

# Automation systems Drive solutions

Controls

**Inverter**

Motors



Gearboxes

Engineering Tools



# Contents of the L-force catalogue

<b>About Lenze</b>		Lenze makes many things easy for you.			
		A matter of principle: the right products for every application.			
		L-force product portfolio			
<b>Automation systems</b>		Controller-based Automation	1.1		
		Drive-based automation	1.2		
<b>Drive solutions</b>		HighLine tasks	2.1		
		StateLine tasks	2.2		
		Baseline tasks	2.3		
<b>Controls</b>	Visualisation	Panel PC v800	3.1		
		Monitor v200	3.2		
	Cabinet Controllers	Controller 3200 C	3.3		
		Controller c300	3.4		
	Panel Controllers	Controller p500	3.5		
		Controller p300	3.6		
		I/O System 1000	3.7		
<b>Inverter</b>	Decentralised	Inverter Drives 8400 protec	4.1		
		Inverter Drives 8400 motec	4.2		
	Cabinet	Servo Drives 9400 HighLine	4.3		
		Inverter Drives 8400 TopLine	4.4		
		Servo-Inverter i700	4.5		
		Inverter Drives 8400 HighLine	4.6		
		Inverter Drives 8400 StateLine	4.7		
		Inverter Drives 8400 Baseline	4.8		
<b>Motors</b>	Servo motors	MCS synchronous servo motors	5.1		
		MCM synchronous servo motors	5.2		
		MD□KS synchronous servo motors	5.3		
		MQA asynchronous servo motors	5.4		
		MCA asynchronous servo motors	5.5		
	Three-phase AC motors	IE3 three-phase AC motors m540/m550-P	5.6		
		Inverter opt. three-phase AC motors MF	5.7		
		IE2 MH three-phase AC motors	5.8		
		IE1 MD three-phase AC motors	5.9		
		Lenze Smart Motor m300	5.10		
		IE3 three-phase AC motors m240-P	5.11		
		IE1/2 three-phase AC motors Basic MD/MH	5.12		
		<b>Gearboxes</b>	Axial gearboxes	g700-P planetary gearbox	6.1
				MPR/MPG planetary gearboxes	6.2
g500-H helical gearboxes	6.3				
g500-S shaft-mounted helical gearbox	6.4				
Right-angle gearboxes	g500-B bevel gearbox		6.5		
Motor data	Assignment see above		6.6		
<b>Engineering Tools</b>	Navigator		7.1		
	Drive Solution Designer	7.2			
	Drive Solution Catalogue	7.3			
	Engineer	7.4			
	PLC Designer	7.5			
	VisiWinNET®	7.6			
	EASY Starter	7.7			

 Selected portfolio  
 Additional portfolio

# Lenze makes many things easy for you.

With our motivated and committed approach, we work together with you to create the best possible solution and set your ideas in motion - whether you are looking to optimise an existing machine or develop a new one. We always strive to make things easy and seek perfection therein. This is anchored in our thinking, in our services and in every detail of our products. It's as easy as that!

**1**

## **Developing ideas**

Are you looking to build the best machine possible and already have some initial ideas? Then get these down on paper together with us, starting with small innovative details and stretching all the way to completely new machines. Working together, we will develop an intelligent and sustainable concept that is perfectly aligned with your specific requirements.

**2**

## **Drafting concepts**

We see welcome challenges in your machine tasks, supporting you with our comprehensive expertise and providing valuable impetus for your innovations. We take a holistic view of the individual motion and control functions here and draw up consistent, end-to-end drive and automation solutions for you - keeping everything as easy as possible and as extensive as necessary.

**3**

## **Implementing solutions**

Our easy formula for satisfied customers is to establish an active partnership with fast decision making processes and an individually tailored offer. We have been using this principle to meet the ever more specialised customer requirements in the field of machine engineering for many years.

**4**

## **Manufacturing machines**

Functional diversity in perfect harmony: as one of the few full-range providers in the market, we can provide you with precisely those products that you actually need for any machine task – no more and no less. Our L-force product portfolio, a consistent platform for implementing drive and automation tasks, is invaluable in this regard.

**5**

## **Ensuring productivity**

Productivity, reliability and new performance peaks on a daily basis – these are our key success factors for your machine. After delivery, we offer you cleverly devised service concepts to ensure continued safe operation. The primary focus here is on technical support, based on the excellent application expertise of our highly-skilled and knowledgeable after-sales team.

# A matter of principle: the right products for every application.

Lenze's extensive L-force product portfolio follows a very simple principle. The functions of our finely scaled products are assigned to the three lines Base-Line, State-Line or High-Line.

But what does this mean for you? It allows you to quickly recognise which products represent the best solution for your own specific requirements.

#### **Powerful products with a major impact:**

- Easy handling
- High quality and durability
- Reliable technologies in tune with the latest developments

Lenze products undergo the most stringent testing in our own laboratory. This allows us to ensure that you will receive consistently high quality and a long service life. In addition to this, five logistics centres ensure that the Lenze products you select are available for quick delivery anywhere across the globe. It's as easy as that!

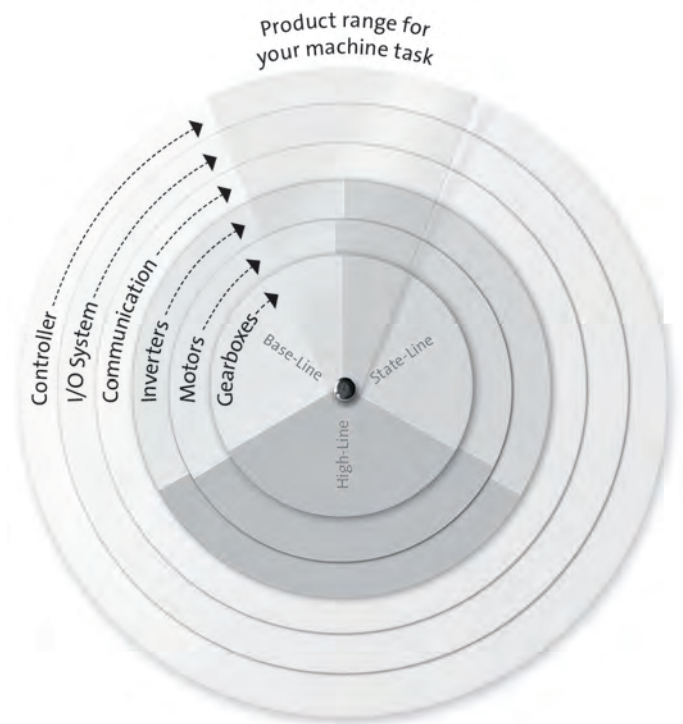

# L-force product portfolio

## Controls

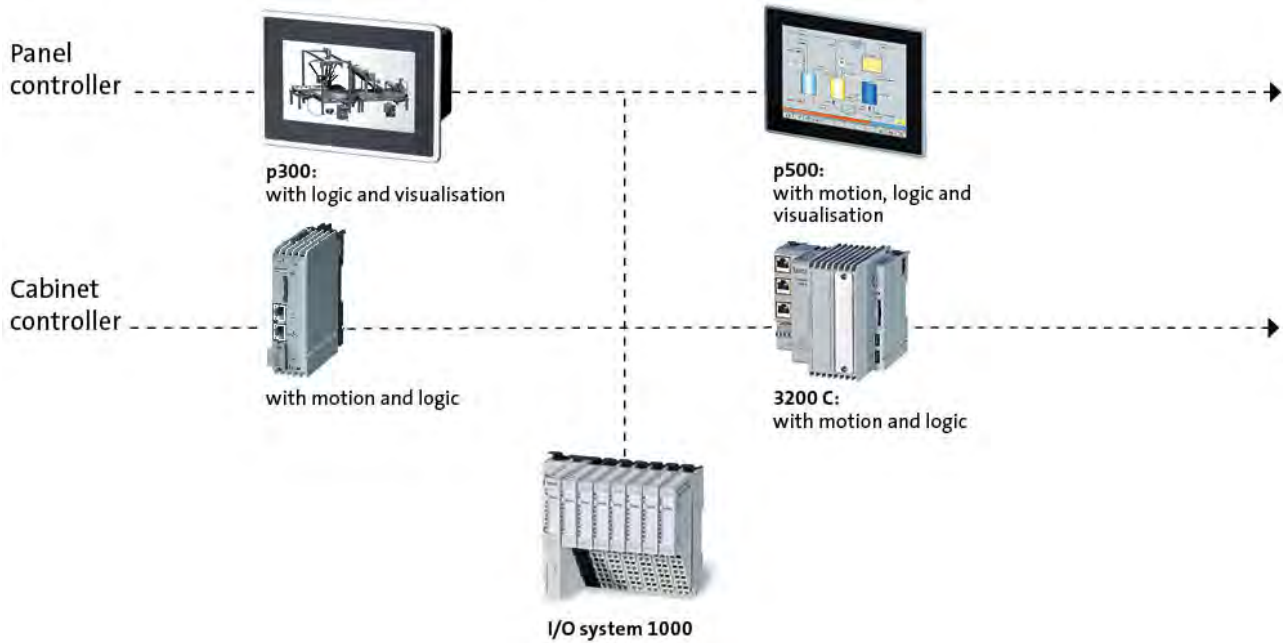

## Engineering Tools

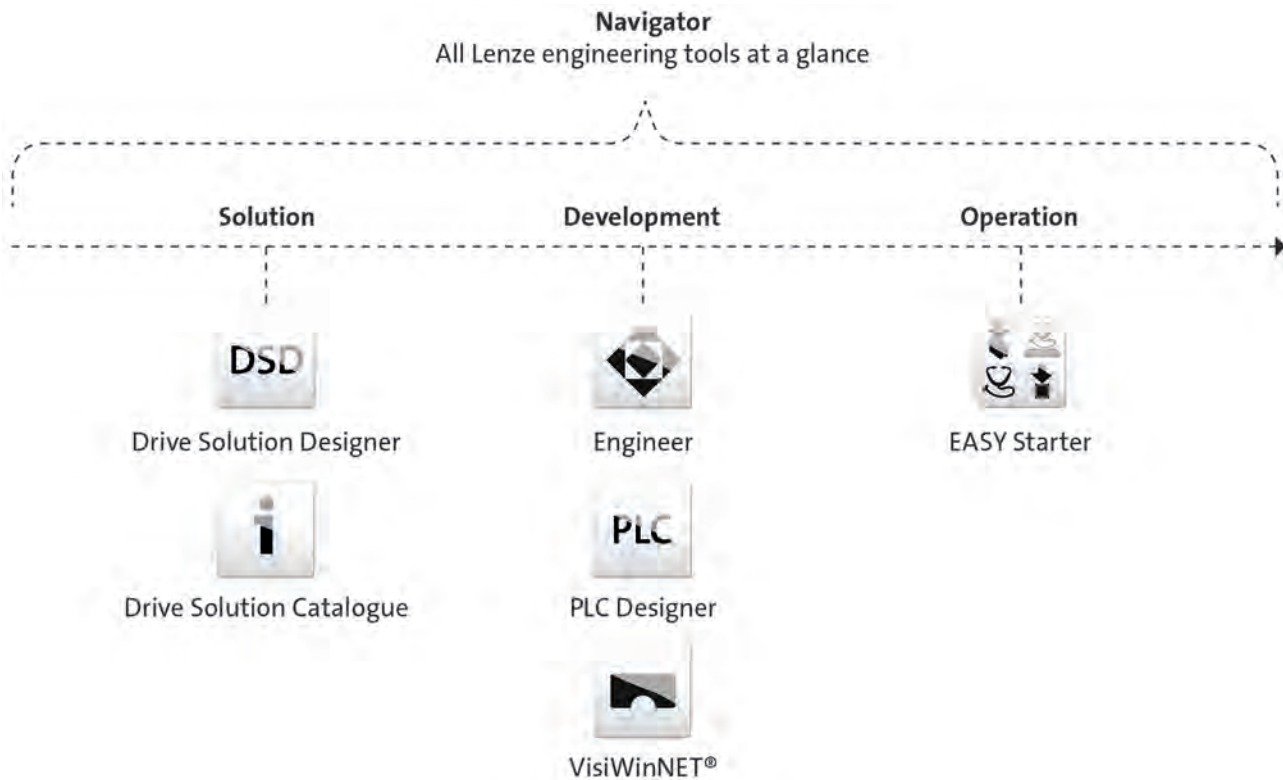

# L-force product portfolio

## Inverter

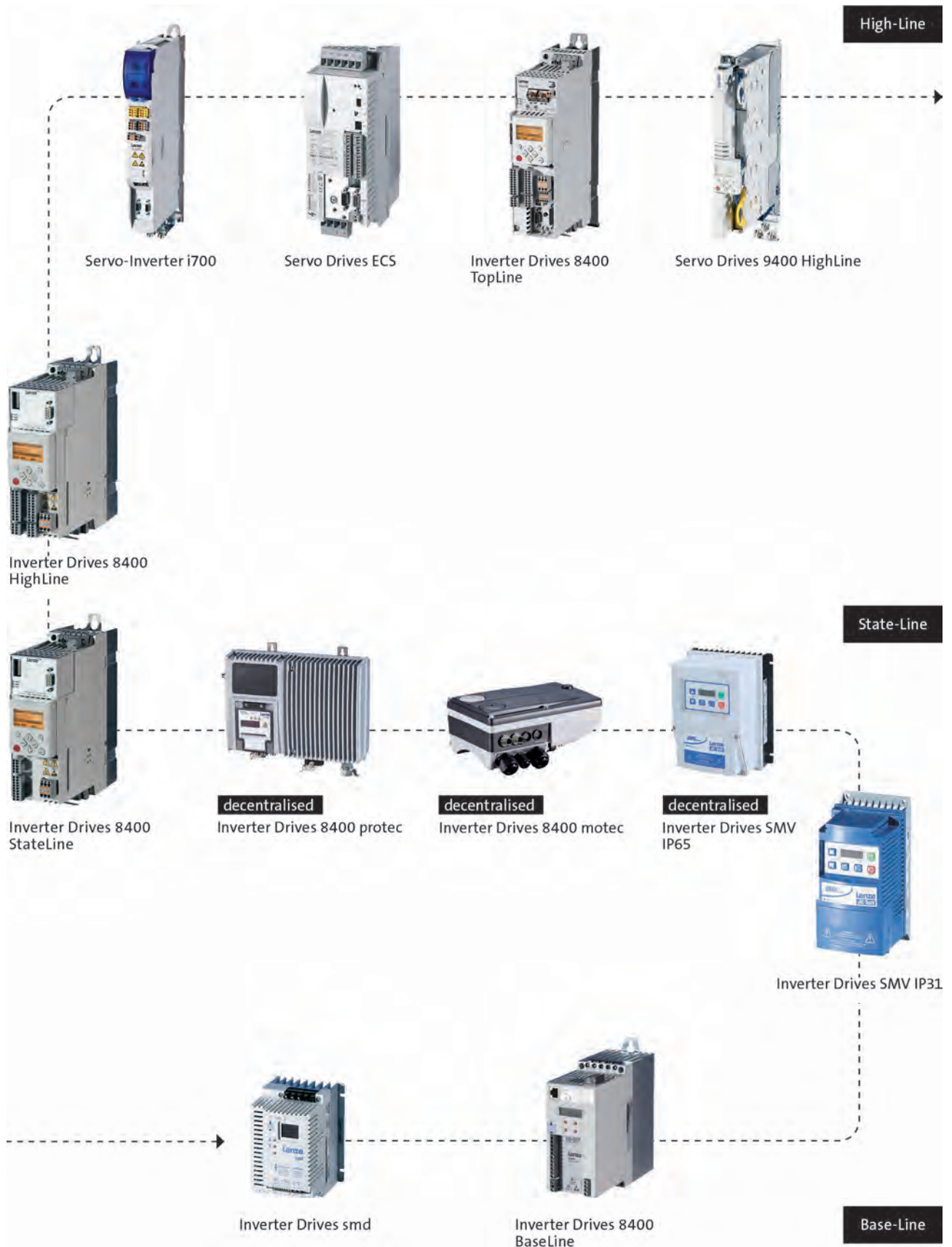

# L-force product portfolio

## Motors

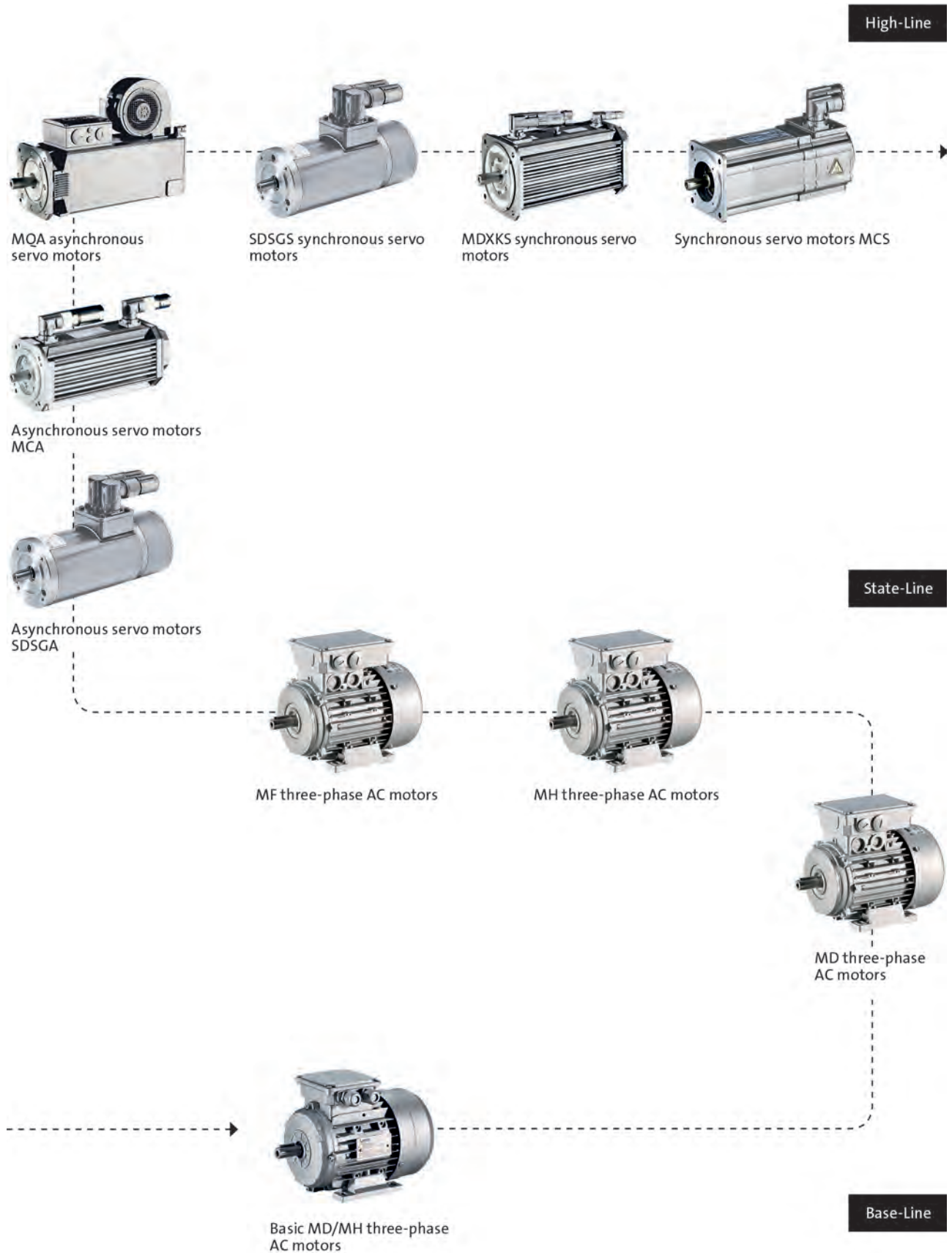



# L-force product portfolio

## Gearboxes

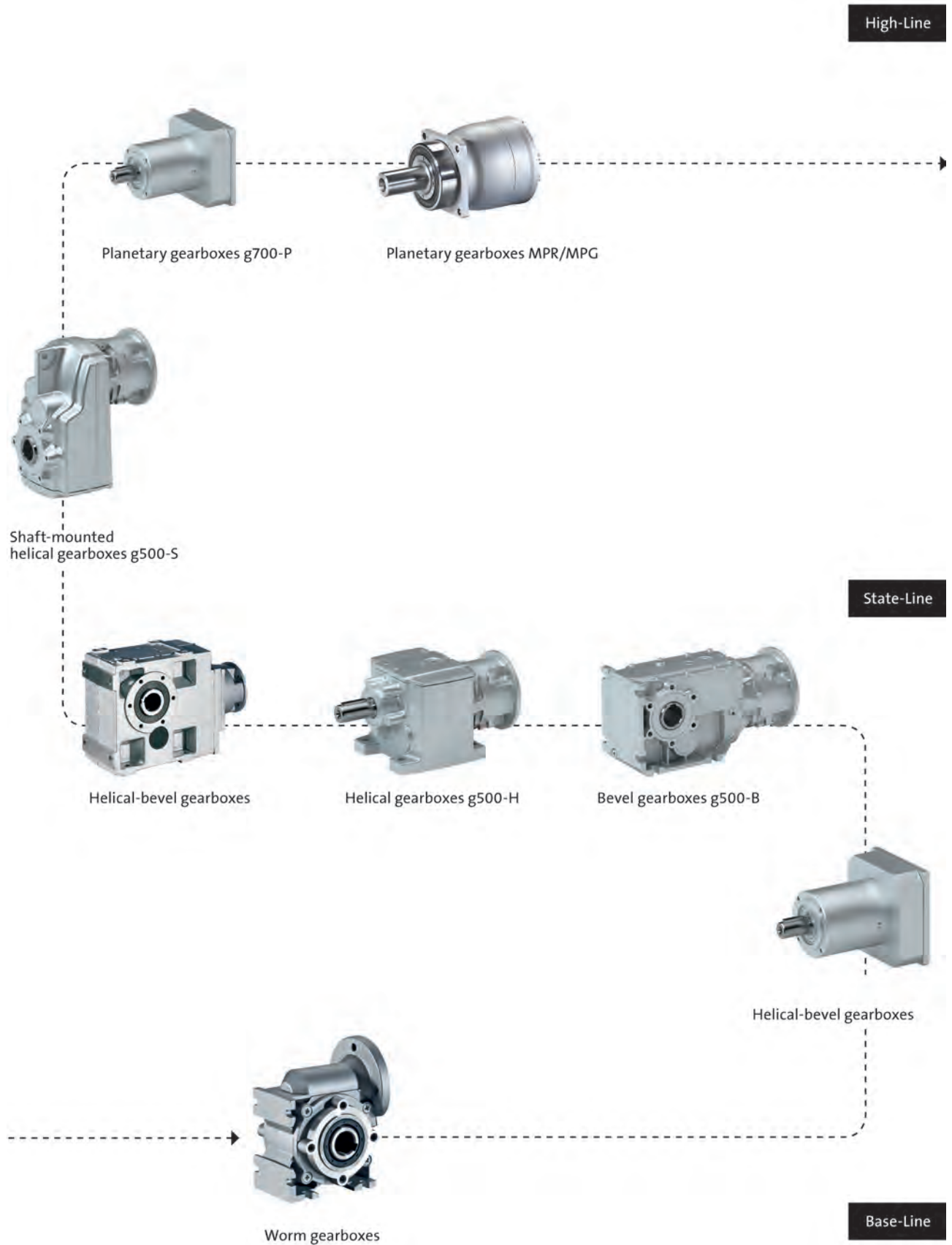



Inverter

# Inverter Drives 8400 protec

0.75 to 7.5 kW





# Inverter Drives 8400 protec

## Contents



<b>General information</b>	Product key	4.1 - 4
	Equipment	4.1 - 5
	List of abbreviations	4.1 - 6
	8400 protec	4.1 - 7
	Functions and features	4.1 - 8
	Operating modes	4.1 - 9
<b>Technical data</b>	Standards and operating conditions	4.1 - 11
	Rated data 400 V	4.1 - 12
	Mains connection	4.1 - 16
	Motor connection	4.1 - 16
	Connection diagrams	4.1 - 17
	Control connections	4.1 - 18
<b>Modules</b>	Memory module	4.1 - 21
	Safety system (STO)	4.1 - 21
	Communication modules	4.1 - 21
	Communication module: CANopen	4.1 - 22
	EtherNet/IP communication module	4.1 - 23
	PROFIBUS communication module	4.1 - 24
PROFINET communication module	4.1 - 25	
<b>Accessories</b>	Brake resistors	4.1 - 27
	USB diagnostic adapter	4.1 - 28
	Diagnosis terminal	4.1 - 29
	Switch/potentiometer unit	4.1 - 29
	System cables	4.1 - 30

# Inverter Drives 8400 protec

## General information



### Product key

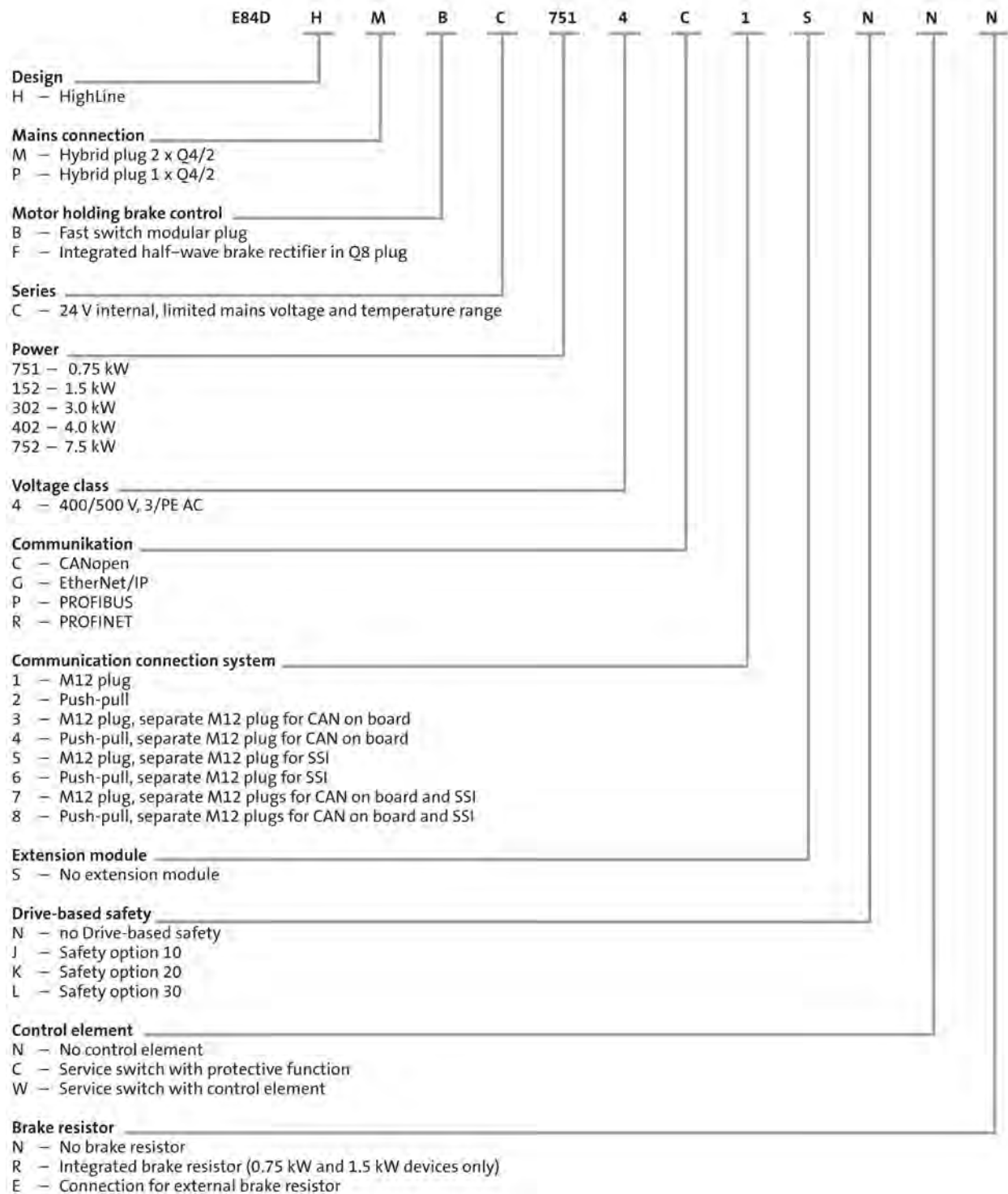

4.1

# Inverter Drives 8400 protec

General information



## Equipment

### Display and diagnostics

Status LEDs  
L-force diagnostic interface

### Safety system

optional

### Mains connection

Pluggable in loop-through technique

### Pluggable control connections

For communication purposes and inputs/outputs



### Brake resistor

Plug connection

### Motor connection

Connection via hybrid cable

4.1

# Inverter Drives 8400 protec

## General information



### List of abbreviations

b	[mm]	Dimensions
C <sub>th</sub>	[kW <sub>s</sub> ]	Thermal capacity
f <sub>ch</sub>	[kHz]	Rated switching frequency
h	[mm]	Dimensions
I <sub>N, out</sub>	[A]	Rated output current
I <sub>N, AC</sub>	[A]	Rated mains current
m	[kg]	Mass
n <sub>max</sub>	[r/min]	Max. speed
P	[kW]	Typical motor power
P <sub>V</sub>	[kW]	Power loss
P <sub>N</sub>	[kW]	Rated power
R <sub>N</sub>	[Ω]	Rated resistance
t	[mm]	Dimensions
U <sub>AC</sub>	[V]	Mains voltage
U <sub>DC</sub>	[V]	DC supply
U <sub>N, AC</sub>	[V]	Rated voltage
U <sub>out</sub>	[V]	Max. output voltage

ASM	Asynchronous motor
DIAG	Slot for diagnostic adapter
DIN	Deutsches Institut für Normung e.V.
EN	European standard
EN 60529	Degrees of protection provided by enclosures (IP code)
EN 60721-3	Classification of environmental conditions; Part 3: Classes of environmental parameters and their limit values
EN 61800-3	Electrical variable speed drives Part 3: EMC requirements including special test methods
IEC	International Electrotechnical Commission
IEC 61508	Functional safety of electrical/electronic/programmable electronic safety-related systems
IM	International Mounting Code
IP	International Protection Code
MCI	Slot for communication module (module communication interface)
NEMA	National Electrical Manufacturers Association
UL	Underwriters Laboratory Listed Product
UR	Underwriters Laboratory Recognized Product
VDE	Verband deutscher Elektrotechniker (Association of German Electrical Engineers)



# Inverter Drives 8400 protec

## General information



### 8400 protec

**The wall-mounted device with a high degree of integration for complex decentralised systems. It excels through its robust design, high degree of operational reliability and fast installation.**

This inverter with a high level of functionality facilitates both basic and servo-based applications. The Inverter Drives 8400 protec is supplied with all modules and interfaces ready to be connected.

#### On-site diagnostics

- A large display provide constant information on the operating status of the device.
- The clearly laid out LEDs provide additional diagnostics information. The fast diagnostics system thereby makes an effective contribution to increasing system availability.

#### Decentralised integrated positioning

- Implementing affordable and decentralised positioning applications with asynchronous motors. Whether switch-off, tabular or absolute positioning: the Inverter Drives 8400 protec offers integrated solutions for these applications. The ability to connect incremental and absolute value encoders rounds off this scope of functions.
- The parameters are set conveniently using the "L-force Engineer" here. The range also has a freely editable function block interconnection for integration of logic, arithmetic and mathematic program through graphic programming.

#### Safety engineering in line with EN ISO 13849-1

- The certified safety system enables not only the connection of local safety elements and safe communication via PROFIsafe, but also a series of safety functions.
- Safe torque off (STO)
- Safe stop 1 (SS1)
- Emergency stop (SSE)
- Safe operation mode selector (OMS)
- Safe enable switch (ES)

#### Further benefits

- 200% overload current (3s)
- V/f control with and without encoder
- Sensorless vector control
- Servo control
- Short-circuit and earth-fault protected
- DC-injection braking
- S-shaped ramp for smooth acceleration
- Max. output frequency 1,000 Hz
- 15 fixed frequencies
- Standardised connectors
- CANopen, EtherNet/IP, PROFIBUS, PROFINET

4.1



Inverter Drives 8400 protec

# Inverter Drives 8400 protec

## General information



### Functions and features

<b>Mode</b>	8400 protec
<b>Control types, motor control</b>	
Sensorless vector control (SLVC)	For three-phase asynchronous motors
V/f control (VFCplus)	For three-phase AC motors and asynchronous servo motor (linear or square-law)
<b>Basic functions</b>	<ul style="list-style-type: none"> <li>Freely assignable user menu</li> <li>Free function block interconnection with extensive function library</li> <li>Parameter change-over</li> <li>DC brake function</li> <li>Flying restart circuit</li> <li>S-shaped ramps for smooth acceleration</li> <li>PID controller</li> <li>15 fixed frequencies</li> <li>Masking frequencies</li> </ul>
<b>Technology applications</b>	<ul style="list-style-type: none"> <li>Speed actuating drive</li> <li>Switch-off positioning without feedback</li> <li>Table positioning without feedback</li> </ul>
<b>Monitoring and protective measures</b>	<ul style="list-style-type: none"> <li>Short circuit</li> <li>Earth fault</li> <li>Overvoltage</li> <li>Motor phase failure</li> <li>Overcurrent</li> <li>I<sup>2</sup> x t-Motor monitoring</li> <li>Motor overtemperature</li> <li>Mains phase failure</li> <li>Protection for cyclical mains switching</li> <li>Motor stalling</li> </ul>
<b>Diagnostics</b>	Data logger, logbook, oscilloscope functions
Status display	18 LEDs
Diagnostic interface	Integrated For USB diagnostic adapter or keypad (diagnosis terminal)
<b>Braking operation</b>	
Brake chopper	Integrated
Brake resistor <sup>1)</sup>	Internal or external

<sup>1)</sup> Internally only for 0.75 and 1.5 kW

# Inverter Drives 8400 protec



## General information

### Operating modes

An inverter enables energy-efficient operation of a system in virtually all application cases. The various operating modes, which can be created by making just a few simple settings, facilitate this. The following characteristics and corresponding specifications listed on the following pages can be used to calculate the optimum operating mode during the project planning phase.

#### Standard setting

In its initial state when delivered, the inverter is set up for basic operation with a three-phase AC motor with V/f control. When operated in this mode, the rated torque of the motor is available in a setting range up to 50 Hz.

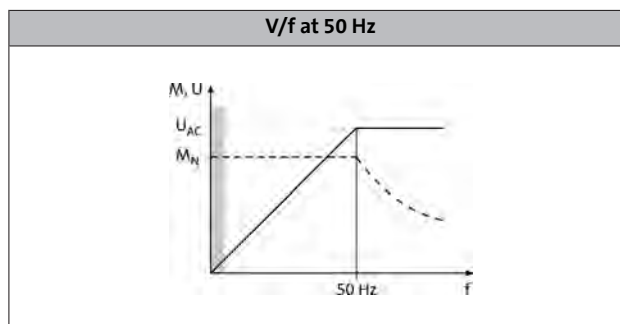

#### Extended setting range up to 87 Hz

If the V/f reference point on the inverter is set to 87 Hz, the rated torque can be used across an extended setting range. Here, a 230/400V motor is for example used and operated in a delta layout with a 400V inverter. The setting range is then increased by 40 %. The inverter must be dimensioned for a rated motor current of 230 V.

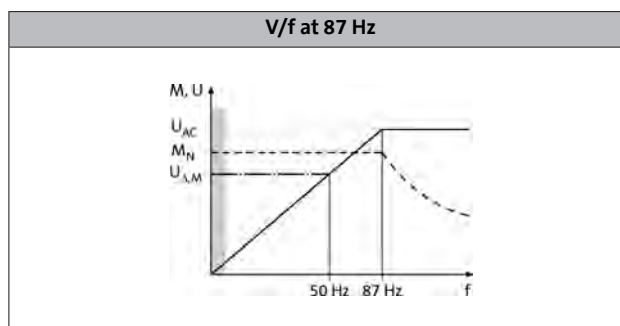

#### Operation with inverter-optimised MF motors

Large setting ranges and optimum operation at the rated torque: these are the strengths of the MF motor when used in combination with an inverter. The motors are optimised for a setting range up to 120 Hz. Compared to conventional 50Hz operation, the setting range increases by 250 %. It is quite simply not possible for a drive to be operated any more efficiently in a machine.

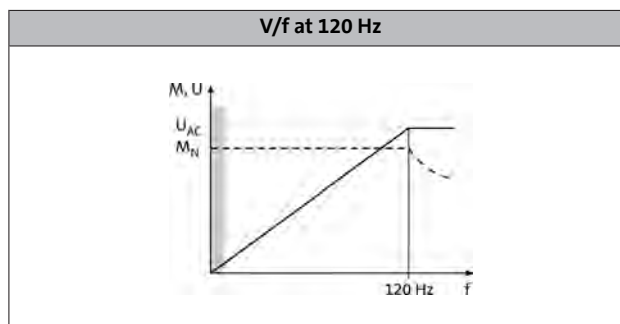

#### Operation with low loads

This operating mode can be used for various applications, e.g. for fans and pumps:

In fan and pump applications, the load behaviour follows a square-law characteristic depending on the speed. Often, an overload capacity of 120% is sufficient. This serves to operate the inverter during operation with increased power, i.e. the inverter can be dimensioned one power size smaller. The square-law characteristic which corresponds to the load behaviour can be set in the inverter.

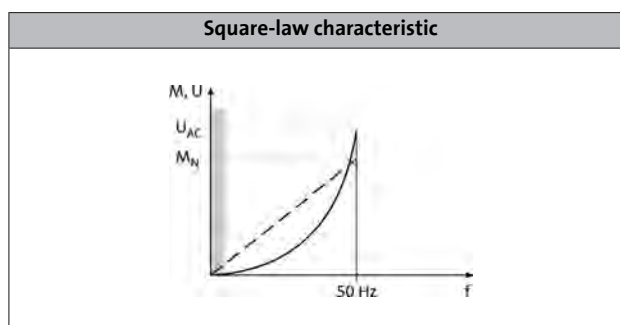

# Inverter Drives 8400 protec

## General information



## Operating modes

### VFC-eco energy saving mode

The Inverter Drives 8400 make energy saving especially easy with the "VFC eco" function. Particularly in the partial load operational range, this function significantly reduces energy requirements. Combined with the new L-force MF three-phase AC motors, this drive solution impresses with the maximum energy efficiency of a Lenze BlueGreen solution.

The "VFC eco" mode adjusts the magnetising current of a motor intelligently to actual requirements. This is particularly useful in partial load operational range, as this is precisely where three-phase AC motors need to be supplied with a greater magnetising current than the operating conditions actually require. The "VFC eco" mode allows losses to be reduced so much that savings of up to 30% can be achieved.

Energy efficiency can then be increased even further with the MF three-phase AC motors. These motors have been specifically designed for operation with frequency inverters. They operate at 120 Hz instead of 50 Hz, as 4-pole three-phase AC motors are at their most efficient at this frequency.

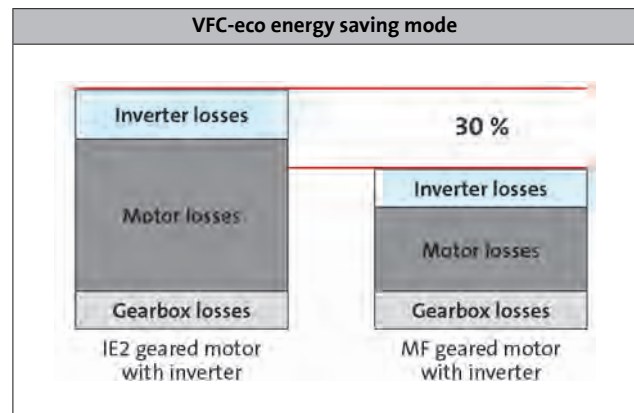

### Overcurrent operation

The inverters can be driven at higher amperages beyond the rated current if the duration of this overcurrent operation is time limited. Two utilisation cycles with a duration of 15 s and 180 s are defined. Within these utilisation cycles, an overcurrent is possible for a certain time if afterwards an accordingly long recovery phase takes place. For both utilisation cycles, a moving average is determined separately. The adjacent diagram shows both cycles: 15 s in red and 180 s in blue. The overload times  $t_{o1}$  are 3 s ( $T_1$ ) and 60 s ( $T_3$ ) respectively, the corresponding recovery times  $t_{re}$  are 12 s ( $T_2$ ) and 120 s ( $T_4$ ) respectively. The following tables show the resulting maximum output currents. Monitoring of the device utilisation ( $I \times t$ ) activates the set error response (trip or warning if one of the two utilisation values exceeds the limit of 100 %).

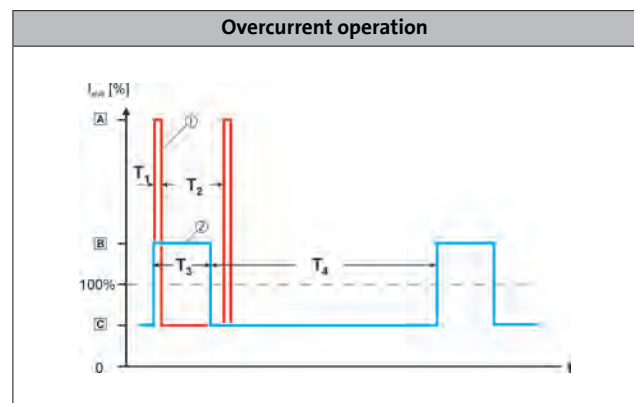

### Switching frequencies

On an inverter, the term "switching frequency" is understood to mean the frequency with which the input and outputs of the output module (inverter) are switched. On an inverter, the switching frequency can generally be set to values between 2 and 16 kHz, whereby the selection is based on the respective power output.

Since losses (in the form of heat) can be generated when switching the modules, the inverter can provide a higher output current at a switching frequency of 2 kHz. In addition to this, it is also important to differentiate between operation at a fixed switching frequency and a variable switching frequency, whereby the switching frequency is automatically reduced based on the output current here.

The data for operation at increased output is permitted for operation at a switching frequency of 2 or 4 kHz and in an ambient temperature of max. 40 °C.

# Inverter Drives 8400 protec

Technical data



## Standards and operating conditions

<b>Mode</b>			
Product			8400 protec
<b>Conformity</b>			
CE			Low-Voltage Directive 2006/95/EC
EAC			TP TC 004/2011 (TR CU 004/2011) TP TC 020/2011 (TR CU 020/2011)
<b>Approval</b>			
UL 508C			Power Conversion Equipment (file no. E132659)
CSA			CSA 22.2 No. 14
<b>Enclosure</b>			
EN 60529			IP65 mit Bedienelement "C" IP64
NEMA 250			
<b>Climatic conditions</b>			
Storage (EN 60721-3-1)			1K3 (temperature: -25 °C ... +60 °C)
Transport (EN 60721-3-2)			2K3 (temperature: -25 °C ... +75 °C)
Operation (EN 60721-3-3)			3K3 (temperature: -25 °C ... +55 °C)
Current derating at over 40°C			2.5 % / K
<b>Site altitude</b>			
Amsl	H <sub>max</sub>	[m]	4000
Current derating at over 1000 m		[%/1000 m]	5
<b>Vibration resistance</b>			
Transport (EN 60721-3-2)			2M2
Operation (EN 60721-3-3)			3M4
Operation (Germanischer Lloyd)			General conditions: acceleration resistant up to 2 g

4.1

<b>Mode</b>			
Product			8400 protec
<b>Supply form</b>			
			Systems with earthed star point (TN and TT systems)
<b>Noise emission</b>			
EN 61800-3			Integrated RFI suppression: cable-guided, category C2 up to 20 m shielded motor cable
<b>Insulation resistance</b>			
EN 61800-5-1			≤ 2000 m amsl overvoltage category III > 2000 m amsl overvoltage category II
<b>Degree of pollution</b>			
EN 61800-5-1			2
<b>Protective insulation of control circuits</b>			
EN 61800-5-1			Safe mains isolation: double/reinforced insulation

# Inverter Drives 8400 protec

## Technical data



### Rated data 400 V

- The data is valid for operation at 400 V AC.
- Unless otherwise specified, the data refers to the default setting.

				
<b>Typical motor power</b>				
4-pole asynchronous motor	P	[kW]	0.75	1.50
<b>Product key</b>				
Inverter			E84D□□□7514□□□□	E84D□□□1524□□□□
<b>Mains voltage range</b>				
	$U_{AC}$	[V]	3/PE AC 320 V-0% ... 440 V+0%, 45 Hz-0 % ... 65 Hz+0%	
<b>Rated mains current</b>				
	$I_{N, AC}$	[A]	4.1	5.5
<b>Rated output current</b>				
	$I_{N, out}$	[A]	2.4	3.9
<b>Rated switching frequency</b>				
	$f_{ch}$	[kHz]	8	
<b>Output current</b>				
2 kHz	$I_{out}$	[A]	2.4	3.9
4 kHz	$I_{out}$	[A]	2.4	3.9
8 kHz	$I_{out}$	[A]	2.4	3.9
16 kHz	$I_{out}$	[A]	1.6	2.3

4.1

### Data for 60 s overload

<b>Max. output current</b>				
	$I_{max, out}$	[A]	3.6	5.9
<b>Overload time</b>				
	$t_{ol}$	[s]	60.0	
<b>Recovery time</b>				
	$t_{re}$	[s]	120.0	

### Data for 3 s overload

<b>Max. short-time output current</b>				
	$I_{max, out}$	[A]	4.8	7.8
<b>Overload time</b>				
	$t_{ol}$	[s]	3.0	
<b>Recovery time</b>				
	$t_{re}$	[s]	75.0	

# Inverter Drives 8400 protec

## Technical data



### Rated data 400 V

- The data is valid for operation at 400 V AC.
- Unless otherwise specified, the data refers to the default setting.

				
<b>Typical motor power</b>				
4-pole asynchronous motor	P	[kW]	0.75	1.50
<b>Product key</b>				
Inverter			E84D□□□7514□□□□	E84D□□□1524□□□□
<b>Power loss</b>				
	P <sub>V</sub>	[kW]	0.066 <sup>2)</sup>	0.084 <sup>2)</sup>
<b>Mass</b>				
	m	[kg]	7.6	
<b>Max. cable length</b>				
Shielded motor cable	I <sub>max</sub>	[m]	20	

4.1

### Brake chopper rated data

<b>Rated power, Brake chopper</b>				
	P <sub>N</sub>	[kW]	0.9	2.0
<b>Max. output power, Brake chopper</b>				
	P <sub>max, 1</sub>	[kW]	3.5	
<b>Min. brake resistance</b>				
	R <sub>min</sub>	[Ω]	150.0	

### Dimensions

<b>Dimensions</b>				
Height	h	[mm]	260 <sup>3)</sup>	
Width	b	[mm]	353	
Depth	t	[mm]	110	

<sup>1)</sup> Technically possible cable lengths, irrespective of EMC requirements

<sup>2)</sup> Operation at rated output current I<sub>N, out</sub>.

<sup>3)</sup> + 30 mm with connector shell.

# Inverter Drives 8400 protec

## Technical data



### Rated data 400 V

- The data is valid for operation at 400 V AC.
- Unless otherwise specified, the data refers to the default setting.

					
<b>Typical motor power</b>					
4-pole asynchronous motor	P	[kW]	3.00	4.00	7.50
<b>Product key</b>					
Inverter			E84D□□□3024□□S□	E84D□□□4024□□S□	E84D□□□7524□□S□
<b>Mains voltage range</b>					
	$U_{AC}$	[V]	3/PE AC 320 V-0% ... 440 V+0%, 45 Hz-0 % ... 65 Hz+0%		
<b>Rated mains current</b>					
	$I_{N, AC}$	[A]	9.7	12.9	20.8
<b>Rated output current</b>					
	$I_{N, out}$	[A]	7.3	9.5	16.0
<b>Rated switching frequency</b>					
	$f_{ch}$	[kHz]	8		
<b>Output current</b>					
2 kHz	$I_{out}$	[A]	7.3	9.5	16.0
4 kHz	$I_{out}$	[A]	7.3	9.5	16.0
8 kHz	$I_{out}$	[A]	7.3	9.5	16.0
16 kHz	$I_{out}$	[A]	4.9	6.3	10.7

### Data for 60 s overload

<b>Max. output current</b>					
	$I_{max, out}$	[A]	11.0	14.3	19.0
<b>Overload time</b>					
	$t_{ol}$	[s]	60.0		
<b>Recovery time</b>					
	$t_{re}$	[s]	120.0		

### Data for 3 s overload

<b>Max. short-time output current</b>					
	$I_{max, out}$	[A]	14.6	19.0	32.0
<b>Overload time</b>					
	$t_{ol}$	[s]	3.0		
<b>Recovery time</b>					
	$t_{re}$	[s]	75.0		



# Inverter Drives 8400 protec

## Technical data



### Rated data 400 V

- The data is valid for operation at 400 V AC.
- Unless otherwise specified, the data refers to the default setting.

					
<b>Typical motor power</b>					
4-pole asynchronous motor	P	[kW]	3.00	4.00	7.50
<b>Product key</b>					
Inverter			E84D□□□3024□□S□	E84D□□□4024□□S□	E84D□□□7524□□S□
<b>Power loss</b>					
	P <sub>V</sub>	[kW]	0.15 <sup>2)</sup>		0.23
<b>Mass</b>					
	m	[kg]	11.3		
<b>Max. cable length</b>					
Shielded motor cable	I <sub>max</sub>	[m]	50		

4.1

### Brake chopper rated data

<b>Rated power, Brake chopper</b>					
	P <sub>N</sub>	[kW]	3.9	5.2	
<b>Max. output power, Brake chopper</b>					
	P <sub>max, 1</sub>	[kW]	11.2		
<b>Min. brake resistance</b>					
	R <sub>min</sub>	[Ω]	47.0		

### Dimensions

<b>Dimensions</b>					
Height	h	[mm]	260 <sup>3)</sup>		
Width	b	[mm]	434		
Depth	t	[mm]	148		

<sup>1)</sup> Technically possible cable lengths, irrespective of EMC requirements

<sup>2)</sup> Operation at rated output current I<sub>N, out</sub>.

<sup>3)</sup> + 30 mm with connector shell.

# Inverter Drives 8400 protec

## Technical data



### Mains connection

- ▶ The mains fuse and cable cross-section specifications are for a mains connection of 3 x 400 V.
- ▶ Class gG/gI fuses or class gRL semiconductor fuses.
- ▶ The cable cross-sections apply to PVC-insulated copper cables.
- ▶ Use for installation with UL-approved cables, fuses and brackets.

Typical motor power	Mains voltage	Product key	Circuit breaker	Fuse		Mains connection
				EN 60204-1	UL	
4-pole asynchronous motor		Inverter		EN 60204-1	UL	Cross-section (without mains choke)
P	$U_{AC}$		I	I	I	q
[kW]	[V]		[A]	[A]	[A]	[mm <sup>2</sup> ]
0.75	3 AC 320 ... 440	E84D□□□7514□□S□	C16	16	15	2.5
1.50		E84D□□□1524□□S□				
3.00		E84D□□□3024□□S□				
4.00		E84D□□□4024□□S□	C20	20	20	4.0
7.50		E84D□□□7524□□S□				

4.1

### Motor connection

- ▶ Keep motor cables as short as possible, as this has a positive effect on the drive behaviour.
- ▶ With group drives (multiple motors on one inverter), the resulting cable length is the key factor. This can be calculated using the hardware manual.
- ▶ Electric strength of the motor cable: 1 kV as per VDE 250-1.

Typical motor power	Mains voltage	Product key	Max. cable length	
			shielded C2 without external measures	shielded C2 with external measures
4-pole asynchronous motor		Inverter		
P	$U_{AC}$		$l_{max}$	$l_{max}$
[kW]	[V]		[m]	[m]
0.75	3 AC 320 ... 440	E84D□□□7514□□S□	20	20
1.50		E84D□□□1524□□S□		
3.00		E84D□□□3024□□S□		
4.00		E84D□□□4024□□S□		
7.50		E84D□□□7524□□S□		

# Inverter Drives 8400 protec

Technical data



## Connection diagrams

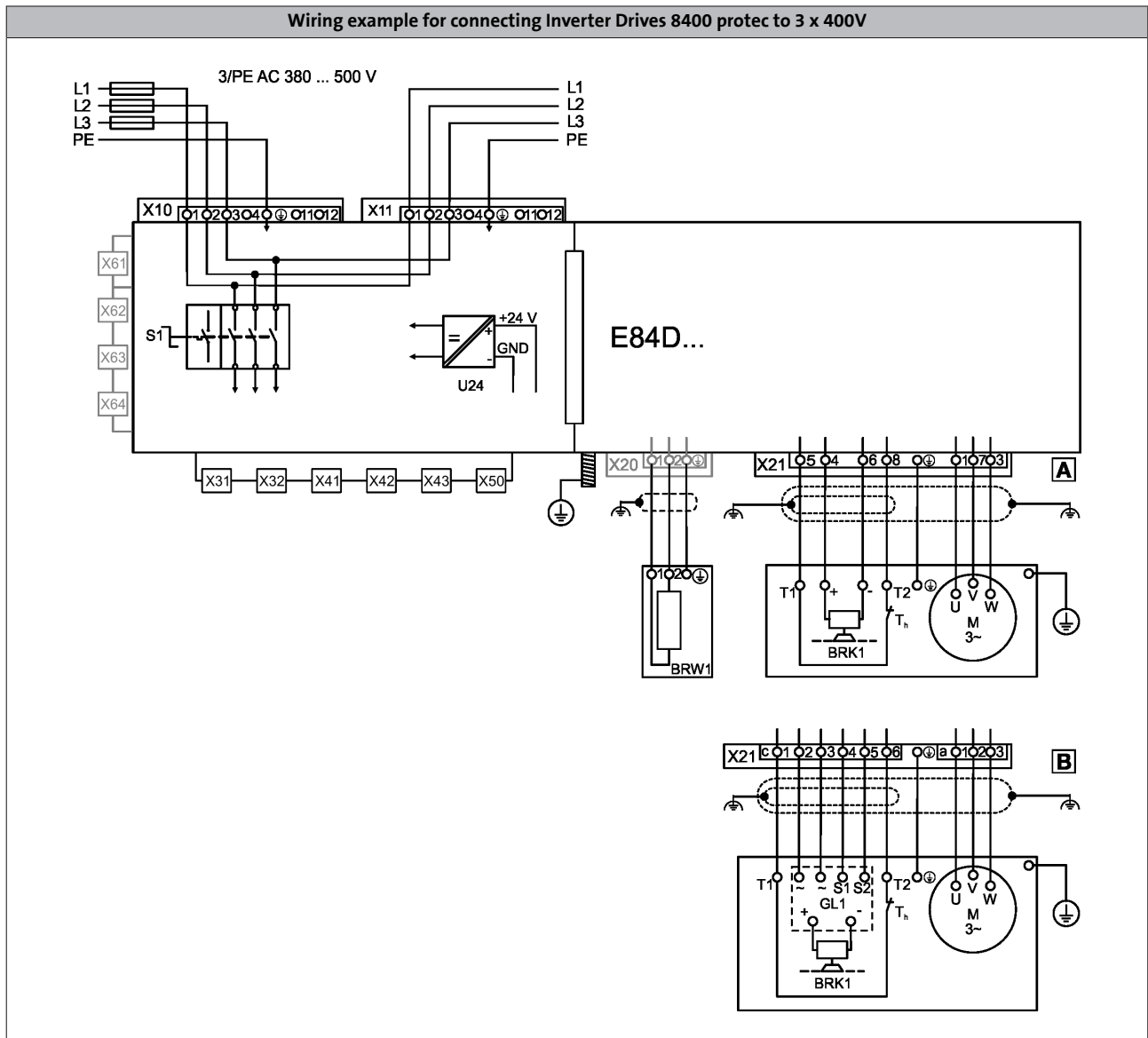

4.1

# Inverter Drives 8400 protec

Technical data



## Control connections

<b>Mode</b>	
Product	8400 protec
<b>Analog inputs</b>	
Number	1 Optional: voltage or current input
Resolution	10 bits
Value range	0 ... 10V, 0/4 ... 20mA
<b>Digital inputs</b>	
Number	6 or 4 (configurable)
Switching level	PLC (IEC 61131-2)
Max. input current	11 mA
Function	
<b>Digital outputs</b>	
Number	0 or 2 (configurable)
Switching level	PLC (IEC 61131-2)
Max. output current	200 mA per output
<b>Relay</b>	
Number	
Contact	
AC connection	
DC connection	
<b>External 24 V DC supply</b>	
	To support communication when the 400 V is switched off
<b>Internal 24 V DC supply</b>	
	Max. 1 A for inputs/outputs and sensor feeds
<b>Interfaces</b>	
CANopen	on board optional
Extensions	Integrated fieldbus communication
Safety engineering	1-2 safe inputs for passive/active actuators/PROFIsafe/PROFIsafe, depending on the safety option selected
<b>Drive interface</b>	
Encoder input	Via 2 digital inputs, HTL, 2-track, 10 kHz 100 kHz, can also be used as a frequency input, SSI input (instead of analog input),

4.1

# Inverter Drives 8400 protec

Technical data



## Control connections

Connection of analog inputs and outputs

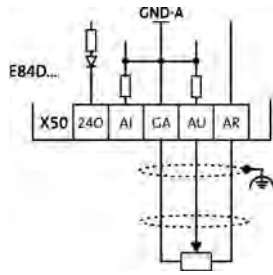

Connection of digital inputs and outputs

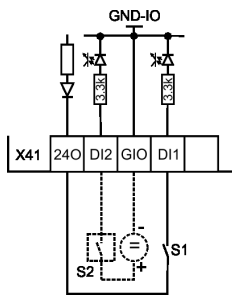

Connection of digital inputs and outputs

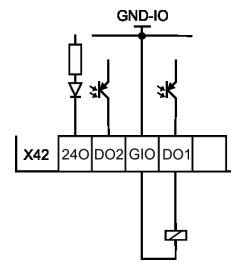

4.1

# Inverter Drives 8400 protec

Technical data

---



# Inverter Drives 8400 protec

## Modules



### Memory module

All drive settings for the 8400 are stored on the memory module, which is a pluggable memory chip. The memory module ensures that drives can be replaced quickly and without errors being made.

Mode	Features	Product key
Memory module	<ul style="list-style-type: none"> <li>For 8400 StateLine, HighLine, Topline and protec</li> <li>Packaging unit: 5 items</li> </ul>	E84AYM10S/M

### Safety engineering

The following safety functions are integrated into the communication modules depending on the device version:

#### Safety option 10

- Safe torque off (STO)
- The drive is safely disconnected when a request is sent via connected active or passive sensors

#### Safety option 20

- Safe torque off (STO)
- Safety stop 1 (SS1)
- Safe stop emergency (SSE)
- Safe operation mode selector (OMS)
- Safe enable switch (ES)
- The drive is safely disconnected by a higher-level safety PLC by means of PROFIsafe/PROFINET

#### Safety option 30

- Safe torque off (STO)
- Safe stop 1 (SS1)
- Safe stop emergency (SSE)
- Safe operation mode selector (OMS)
- Safe enable switch (ES)
- The drive is safely disconnected by a higher-level safety PLC by means of PROFIsafe/PROFINET and via connected active or passive sensors

4.1

Safety functions	10	20	30
Basic error limit (at 25 °C)			
<b>Certification</b>			
EN ISO 13849-1	Category 4 / PLe	Category 3 / PLe	
EN 61800-5-2		SIL 3	
EN 62061		SIL 3	
IEC 61508		SIL 3	
<b>Fail-safe state</b>		Safe torque off	

### Communication modules

Inverter Drives 8400 protec are supplied with permanently installed communication modules. As well as containing the components for fieldbus communication, these modules also include the digital inputs and outputs. An analog input or a synchronous serial interface (SSI) can also be provided as an option.

#### Overview

Communication module	Digital inputs	Digital outputs	Analog inputs
	Number	Number	Number
CANopen	6 or 4 (configurable)	0 or 2 (configurable)	1 <sup>1)</sup>
EtherNet/IP	6 or 4 (configurable)	0 or 2 (configurable)	1 <sup>1)</sup>
PROFIBUS	6 or 4 (configurable)	0 or 2 (configurable)	1 <sup>1)</sup>
PROFINET	6 or 4 (configurable)	0 or 2 (configurable)	1 <sup>1)</sup>

<sup>1)</sup> Or as a synchronous serial interface (SSI).

# Inverter Drives 8400 protec

## Modules



### Communication module: CANopen

The CANopen communication module allows the 8400 protec to be controlled via the "CANopen" bus system using digital control signals. It is integrated in the inverter with the product key E84D□□□□□□□□C.

The benefits of this system include:

- Easy, yet very powerful bus system
- Easy system integration, as a wide range of sensors and actuators is available in the market.

Mode	Features
Communication module	
CANopen	<ul style="list-style-type: none"> <li>• Addressing via DIP switches or parameters</li> </ul>

### Technical data

Mode			
Communication module			CANopen
<b>Communication</b>			
Medium			DIN ISO 11898
Communication profile			CANopen, DS301 V4.02 Lenze system bus
Device profile			Lenze device control
<b>Baud rate</b>			
	b	[kBit/s]	20 50 125 250 500 800 1000
<b>Node</b>			
			Slave Multi-master
<b>Network topology</b>			
			Line with terminating resistors (120 ohm) at both ends
<b>Number of logical process data channels</b>			
			4 (each with 1 - 8 bytes)
<b>Number of logic parameter data channels</b>			
			5
<b>Number of bus nodes</b>			
			63
<b>Max. cable length</b>			
per bus segment	$l_{max}$	[m]	17 for 1000 kbps 40 for 800 kbps 110 for 500 kbps 290 for 250 kbps 630 for 125 kbps 1500 for 50 kbps 3900 for 20 kbps 8000 for 10 kbps

4.1





### EtherNet/IP communication module

The EtherNet/IP communication module based on standard TCP and UDP enables the Inverter Drives 8400 motec to support a continuous communication from the field level right through to the controlling system. The product key E84D□□□□□□□□□□G

indicates an inverter with an integrated communication module

The benefits of this system include:

- Currently widespread fieldbus based on real-time Ethernet
- Supports DHCP and BootP in allocating the IP address
- Devices linked via EtherNet/IP can be implemented seamlessly and with minimum configuration expense via mapping into the I/O tree of the RSLogix programming tool

Mode	Features
Communication module	
EtherNet/IP	• Supports multicast messages, UCMM, ACD, BOOTP/DHCP, VLAN-Tagging/DSCP

### Technical data

<b>Mode</b>				EtherNet/IP
Communication module				
<b>Communication</b>				
Medium				CAT5e S/FTP according to ISO/ICE11801 / EN50173
Communication profile				EtherNET/IP, AC Drive
<b>Baud rate</b>				
	b	[MBit/s]		10/100 (full duplex/half duplex)
<b>Node</b>				Slave (Adapter)
<b>Network topology</b>				Tree, star and line
<b>Process data words (PCD)</b>				
16 Bit				1 ... 16
<b>Number of bus nodes</b>				max. 254 im Subnetz
<b>Max. cable length</b>				
between two nodes	$l_{max}$	[m]		100

# Inverter Drives 8400 protec

## Modules



### PROFIBUS communication modules

With the PROFIBUS communication module, the 8400 protec supports the most widespread current fieldbus system. It is integrated in the inverter with the product key E84D□□□□□□□□P.

The benefits of this system include:

- Widespread and very powerful fieldbus system
- Integrated I/O node. Capable of communication and reading inputs even when the 400V supply is switched off.

Mode	Features
Communication module	
PROFIBUS	<ul style="list-style-type: none"> <li>• DPVO: basic functionalities such as cyclical data exchange and diagnostics</li> <li>• DPV1: supports acyclical data exchange for parameter setting, operation and alarm handling</li> </ul>

### Technical data

Mode			
Communication module			PROFIBUS
<b>Communication</b>			
Medium			RS 485
Communication profile			PROFIBUS-DP-V1 PROFIBUS-DP-V0
Device profile			PROFIDrive, version 3
<b>Baud rate</b>			
	b	[kBit/s]	9.6 ... 12 000 (automatic detection)
<b>Node</b>			
			Slave
<b>Network topology</b>			
			with repeater: line or tree without repeater: line
<b>Process data words (PCD)</b>			
16 Bit			1 ... 16
<b>DP user data length</b>			
			Optional parameter channel (4 words) + process data words
<b>Number of bus nodes</b>			
			31 slaves + 1 master per bus segment With repeaters: 125
<b>Max. cable length</b>			
per bus segment	$I_{max}$	[m]	1200 (depending on the baud rate and the cable type used)

4.1

# Inverter Drives 8400 protec

## Modules



### PROFINET communication modules

With the PROFINET communication module, the 8400 protec supports a fieldbus system for continuous communication from the field level right through to company management level. It is integrated in the inverter with the product key E84D□□□□□□□□R.

The benefits of this system include:

- Fieldbus system capable of handling large data volumes
- Use of IT standards
- Integrated switch allows direct looping of PROFINET via the inverters
- Integrated I/O node. Capable of communication and reading inputs even when the 400V supply is switched off.

Mode	Features
Communication module	
PROFINET	<ul style="list-style-type: none"> <li>• Automatic detection of the 100 Mbps baud rate</li> <li>• Creation of a line topology through integrated 2-port switch</li> <li>• Support for I&amp;M 0 to 4 functionality for identification of the standard device</li> <li>• Link / Activity</li> </ul>

### Technical data

Mode			
Communication module			PROFINET
<b>Communication</b>			
Medium			CAT5e S/FTP according to ISO/ICE11801 (2002)
Communication profile			PROFINET RT Conf. Class B
<b>Baud rate</b>			
	b	[MBit/s]	10/100
<b>Node</b>			
			Slave (Device)
<b>Network topology</b>			
			Tree, star and line
<b>Number of logical process data channels</b>			
			1 ring as client (media redundancy)
<b>Process data words (PCD)</b>			
16 Bit			1 ... 16
<b>Max. cable length</b>			
between two nodes	$l_{max}$	[m]	100

# Inverter Drives 8400 protec

Modules



4.1



### Brake resistors

An external brake resistor is required to brake high moments of inertia or in the event of prolonged operation in generator mode; this resistor converts braking energy into heat.

The brake resistors recommended in the table below have been dimensioned for approx. 1.5 times the regenerative power, with a cycle time of 15/135 s (brake/rest ratio). These brake resistors generally meet the usual requirements of standard applications.

The brake resistors are fitted with a thermostat (potential-free NC contact).



Brake resistor

Typical motor power	Mains voltage	Product key		Rated resistance	Rated power	Thermal capacity	Dimensions	Mass
		Inverter	Brake resistor					
4-pole asynchronous motor								
P	U <sub>AC</sub>			R <sub>N</sub>	P <sub>N</sub>	C <sub>th</sub>	h x b x t	m
[kW]	[V]			[Ω]	[kW]	[KWs]	[mm]	[kg]
0.75	3 AC 320 ... 440	E84D□□□7514□□S□	ERBS240R300W	240.0	0.30	45.0	382 x 124 x 122	2.0
1.50		E84D□□□1524□□S□		180.0	0.35	53.0		
3.00		E84D□□□3024□□S□	ERBS047R400W	47.0	0.40	60.0	400 x 110 x 105	2.3
4.00		E84D□□□4024□□S□						
7.50		E84D□□□7524□□S□						

# Inverter Drives 8400 protec

## Accessories



### USB diagnostic adapter

The operation, parameter setting and diagnostics of the Inverter Drives 8400 and the Servo Drives 9400 via the L-force diagnostics is made with the keypad X400 or a PC. The connection of a PC can be made via a USB interface and the USB diagnostic adapter.

For connecting the USB diagnostic adapter with the L-force diagnostics interface (DIAG) at the inverter, three different connecting cables are separately available in the lengths 2.5 m, 5 m and 10 m. The connection can be established during operation. The engineering tools EASY Starter or Engineer can be used to carry out the operation, parameter setting or diagnostics of the inverters. Both tools have simple intuitive surfaces. This enables a quick and easy commissioning.

Optionally to the USB diagnostic adapter, the PC system bus adapter can be used. For this purpose, a CANopen interface must be available at the inverter.



USB diagnostic adapter incl. connecting cable to the PC

4.1

- The engineering tools EASY Starter or Engineer are used for operation, parameter setting and diagnostics of the inverters.

Mode		Features	Product key
USB diagnostic adapter		<ul style="list-style-type: none"> <li>• Input-side voltage supply via USB connection on PC</li> <li>• Output-side voltage supply via inverter's diagnostic interface</li> <li>• Diagnostic LEDs</li> <li>• Electrical isolation of PC and inverter</li> <li>• Hot-pluggable</li> </ul>	E94AZCUS

### Connecting cables for USB diagnostic adapter

Mode	Features	Product key
Connecting cable for USB diagnostic adapter	• Length: 2.5 m	EWL0070
	• Length: 5 m	EWL0071
	• Length: 10 m	EWL0072

# Inverter Drives 8400 protec

## Accessories



### Diagnosis terminal

The diagnosis terminal can be used as an alternative to a PC if you are looking for an easy way to operate the inverter, set parameters or carry out diagnostics locally. The structured menus and plain text display provide quick access to data.

The diagnosis terminal can be plugged into the inverter's L-force diagnostic interface (DIAG) from the outside.



Diagnosis terminal

Mode	Features	Slot	Product key
Diagnosis terminal	<ul style="list-style-type: none"><li>• Diagnosis terminal inside robust housing</li><li>• incl. 2.5 m cable</li><li>• Degree of protection IP20</li><li>• For 8400 motec and protec.</li></ul>	DIAG	EZAEBK2003

4.1

### Switch/potentiometer unit

The switch / potentiometer unit is fitted directly to the 8400 motec or in a different position within the system. An analogue setpoint can be specified with the switch/potentiometer unit and the control connections integrated in the inverter by using the integrated potentiometer; the rotary switch can, for example, be used to start/stop the drive or change the direction of rotation. The switch/potentiometer unit is supplied with a 2.5 m connection cable.



Switch/potentiometer unit

Mode	Product key
Switch/potentiometer unit (IP65)	E82ZBU



### System cables

For connection of the motor, Lenze provides finished hybrid cables. They are optimally matched to the connection between the Drive Package components. Motor connection, blower connection, brake connection and temperature monitoring are integrated in the cables. Cables up to a length of 100 m can be selected in increments of 0.1 m.

#### 10-pole cables

Available with cross-sections 1.5<sup>2</sup> and 2.5<sup>2</sup> with connection for brake or thermal contact.

Product series	Cable type	Connection cable	Cable length in decimetres	Cable end on the motor side (socket)	Cable end on the controller side
E Y P Motor		A	0 0 0 3 5 0 0 0 Minimum length Maximum length		
Fixed installation	0 0 3 9	1.5 mm <sup>2</sup>		H 0 7 Modular 16A	A 0 0 Without plug-in connector Q 0 8 Modular 40A
	0 0 4 0	2.5 mm <sup>2</sup>		A 0 0 Without plug-in connector H 0 8 Modular 16A	Q 0 8 Modular 40A A 0 0 Without plug-in connector
	0 0 4 6	4.0 mm <sup>2</sup>		H 0 9 Modular 40A	A 0 0 Without plug-in connector Q 0 9 Modular 40A
	0 0 4 7	10.0 mm <sup>2</sup>		A 0 0 Without plug-in connector H 1 4 Modular 40A	Q 0 9 Modular 40A A 0 0 Without plug-in connector
				H 1 5 Modular 40A	A 0 0 Without plug-in connector



# Inverter Drives 8400 protec

## Accessories



### 8-pole cables

Available with cross-sections 1.5<sup>2</sup> and 2.5<sup>2</sup> with connection for brake and thermal contact.

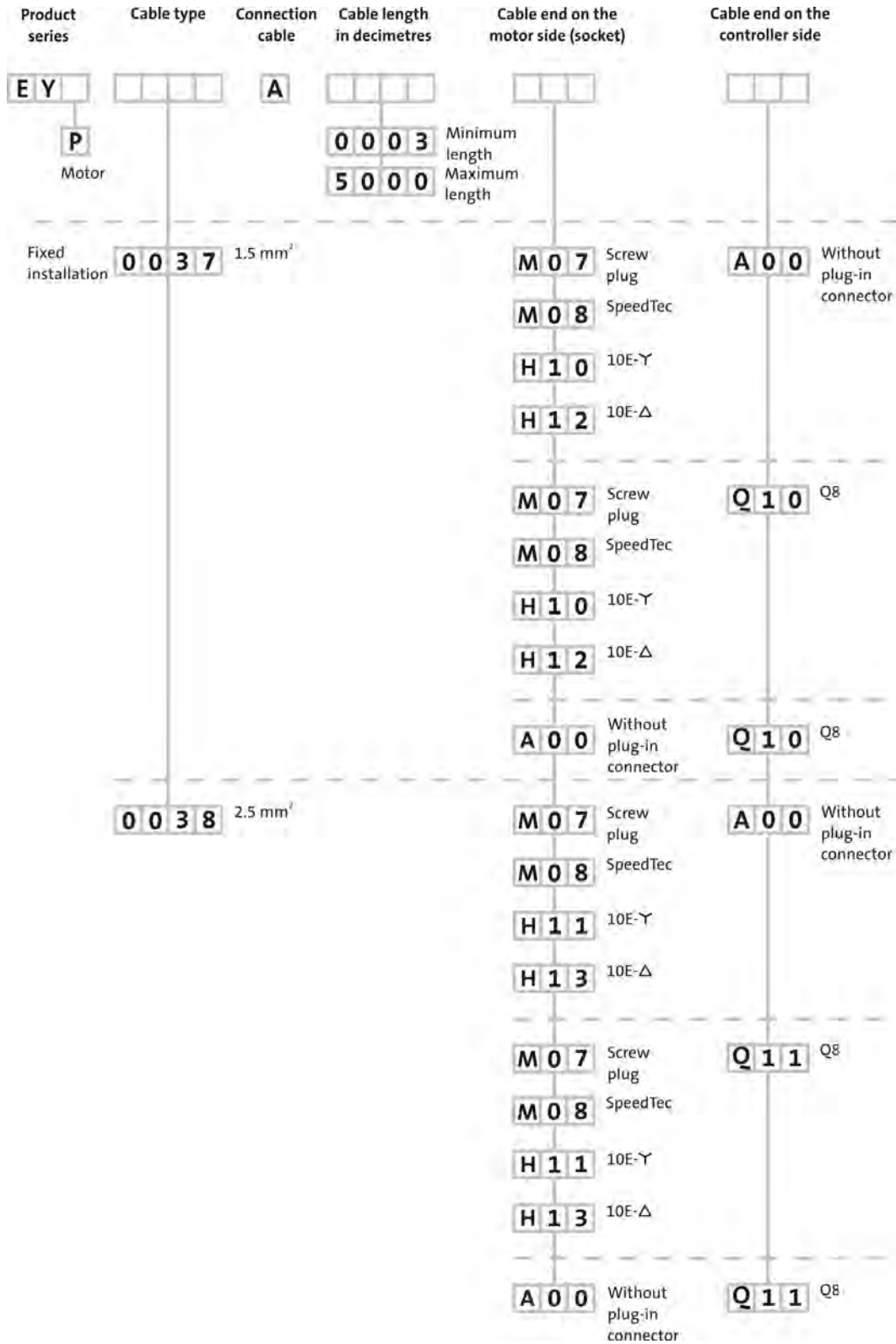

4.1

# Inverter Drives 8400 protec

Accessories



4.1

Inverters

# Inverter Drives 8400 motec

0.37 ... 7.5 kW





# Inverter Drives 8400 motec

## Contents



<b>General information</b>	List of abbreviations	4.2-4	
	8400 motec	4.2-5	
	The combinable units	4.2-6	
	Drive Unit	4.2-7	
	Functions and features	4.2-8	
<b>Project planning</b>	Operating modes	4.2-9	
	Topologies for decentralised drive technology	4.2-11	
	Extension of safety technology	4.2-11	
	Application example whole system	4.2-12	
<b>Technical data</b>	Standards and operating conditions	4.2-13	
	Rated data 400 V	4.2-14	
	Mains connection	4.2-24	
	Motor connection	4.2-24	
	Power connections	4.2-25	
<b>Module</b>	Communication Unit	4.2-26	
	General technical data	4.2-27	
	Safety technology	4.2-28	
	Communication modules without fieldbus link Basic I/O	4.2-29	
	Communication module without fieldbus link Standard I/O	4.2-30	
	Communication module without fieldbus link Extended I/O	4.2-31	
	Communication module AS-Interface (AS-i)	4.2-32	
	AS-Interface communication module	4.2-33	
	CANopen communication module	4.2-35	
	EtherCAT® communication module	4.2-38	
	EtherNet/IP communication module	4.2-41	
	PROFIBUS communication module	4.2-44	
	PROFINET communication module	4.2-47	
	<b>Accessories</b>	Wiring Unit for motor mounting	4.2-50
		Frame Unit without switch for wall mounting	4.2-51
Wall mounting		4.2-51	
Frame Unit with switch for wall mounting		4.2-52	
Overview of possible components of the system		4.2-53	
Memory module		4.2-54	
M-12 connector		4.2-54	
Plug-in module		4.2-54	
Plugs		4.2-55	
Brake resistor		4.2-56	
External brake resistors		4.2-56	
USB diagnostic adapter		4.2-57	
Diagnosis terminal		4.2-58	
Switch/potentiometer unit		4.2-58	
Motor mounting		4.2-59	
Motor mounting set type code		4.2-59	
<b>Order options</b>		Motor mounting accessories	4.2-60
	Field package without switch	4.2-61	
	Field package with switch	4.2-63	

# Inverter Drives 8400 motec

## General information



### List of abbreviations

b	[mm]	Width
C <sub>th</sub>	[kWs]	Thermal capacity
f <sub>ch</sub>	[kHz]	Rated switching frequency
h	[mm]	Height
I <sub>N, out</sub>	[A]	Rated output current
I <sub>N, AC</sub>	[A]	Rated mains current
m	[kg]	Mass
n <sub>max</sub>	[rpm]	Max. speed
P	[kW]	Typical motor power
P <sub>V</sub>	[kW]	Power loss
P <sub>N</sub>	[kW]	Rated power
R <sub>N</sub>	[Ω]	Rated resistance
t	[mm]	Depth
U <sub>AC</sub>	[V]	Mains voltage
V <sub>DC</sub>	[V]	DC supply
U <sub>N, AC</sub>	[V]	Rated voltage
V <sub>out</sub>	[V]	Max. output voltage

ASM	Asynchronous motor
DIAG	Slot for diagnostic adapter
DIN	Deutsches Institut für Normung e.V.
EN	European standard
EN 60529	Degrees of protection provided by enclosures (IP code)
EN 60721-3	Classification of environmental conditions; part 3: Classes of environmental parameters and their limit values
EN 61800-3	Electrical variable speed drives Part 3: EMC requirements including special test methods
IEC	International Electrotechnical Commission
IEC 61508	Functional safety of electrical/electronic/programmable electronic safety-related systems
IM	International Mounting Code
IP	International Protection Code
MCI	Slot for communication module (Module Communication Interface)
NEMA	National Electrical Manufacturers Association
UL	Underwriters Laboratory Listed Product
UR	Underwriters Laboratory Recognized Product
VDE	Verband deutscher Elektrotechniker (Association of German Electrical Engineers)

# Inverter Drives 8400 motec

## General information



### 8400 motec

The Inverter Drives 8400 motec excel through the greatest possible user-friendliness during operation and installation.

Particularly when used for decentralised drive solutions, the Inverter Drives 8400 motec are able to demonstrate their exemplary efficiency with regard to space, time and energy.

#### Space savings

- Integrated safety technology and fieldbus communication tailored to individual requirements
- The modular structure minimises your spares inventory

#### Time benefits

- Reduction in mounting and installation times thanks to the pluggable connection system: "Unpack, connect and you're done!"
- Easy replacement of the memory module facilitates standard set-up and increases availability

#### Energy efficiency

- "VFC eco" mode offers intelligent adaptation of the magnetising current.
- Energy savings of up to 30% in partial load operational range are possible

#### Further benefits

- 200 % overload current (3s)
- V/f control with and without encoder
- Sensorless vector control
- Short circuit and earth fault proof
- DC-injection braking
- S-ramps for smooth acceleration
- Max. output frequency 300 Hz
- CANopen, PROFIBUS, PROFINET, EtherCAT®, EtherNet/IP and AS-Interface
- Safety function STO

#### Wonderfully simple

- Large LED ensures that operating status is clearly visible from a distance; blinking informs users as to error causes.

#### Mechanically and electrically robust

- Thanks to the high degree of protection (IP65), ideally suited for use in the harshest environments.

#### A win for decentralised applications

- The 8400 motec meets all requirements of a modern, universally deployable and cost-efficient motor inverter. This makes it ideally suited for decentralised duties in the field of intralogistics, such as at airports or distribution centres.

4.2



Inverter Drives 8400 motec as motor version



Inverter Drives 8400 motec as wall-mounted version (Field Package)



Inverter Drives 8400 motec as wall-mounted version (Field Package) with main and service switch

# Inverter Drives 8400 motec

## General information



### The combinable units

The modular, sophisticated design of the 8400 motec, which comprises the “Drive Unit”, “Communication Unit” and “Wiring Unit”, shows how flexible this drive is. After selecting which units you want, you can order three different versions of the 8400 motec:

- **Drive package**  
The 8400 motec is delivered mounted on a Lenze geared motor/ three-phase AC motor.
- **Motor mounting set**  
The 8400 motec can be mounted on the motor via different wiring units (depending on the motor frame size) with four screws.
- **Field package with/without switch**  
The 8400 motec can be mounted on a wall/machine frame using screws. The type ‘with switch’ features a frame unit with a main switch and control elements.

When the units are individually ordered, they are delivered in separate packages.

#### Drive Unit

- Inverter power section
- Easy commissioning via DIP switch, potentiometer or diagnosis terminal
- Easy to replace memory module
- A large LED display to show statuses

#### Communication Unit

- Interface for I/Os and fieldbus links
- AS-Interface, CANopen, EtherCAT®, Ethernet/IP, PROFIBUS or PROFINET
- I/Os and on-board safety technology
- Pluggable M12 connection system

#### Wiring Unit and Frame Unit

- Connections to mains and drive
- Flexible connection options such as cable glands and diverse plug-in connectors
- Connection for brake resistor
- Connection for spring-applied brake

4.2

### Motor mounting set

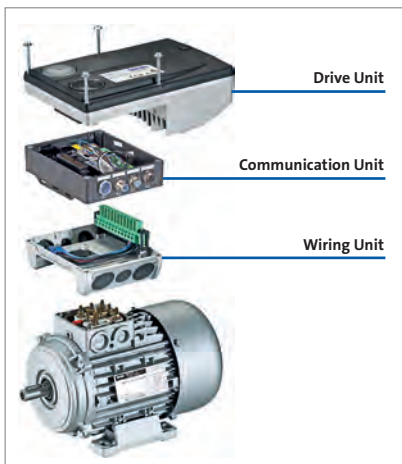

8400 motec 0.37 ... 3.0 kW

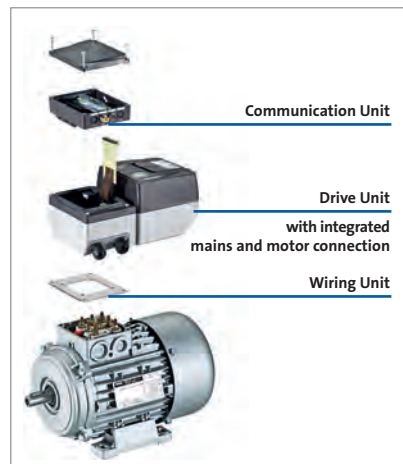

8400 motec 4.0 ... 7.5 kW

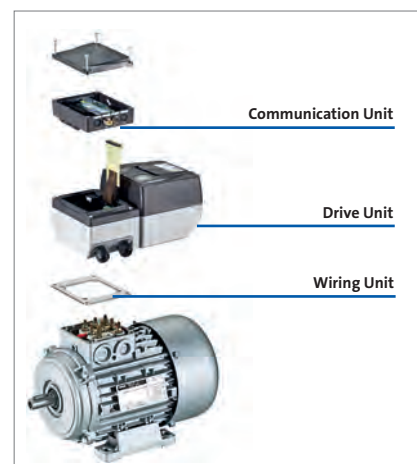

8400 motec 4.0 ... 7.5 kW

### Field package

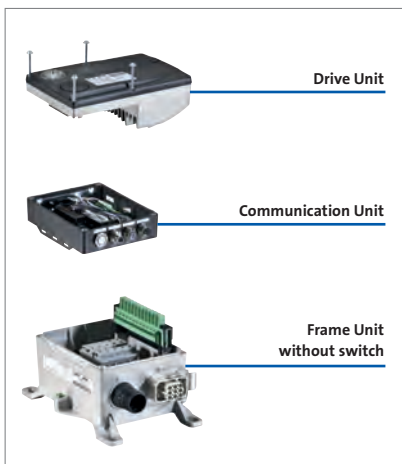

8400 motec field package without switch  
0.37 ... 3.0 kW

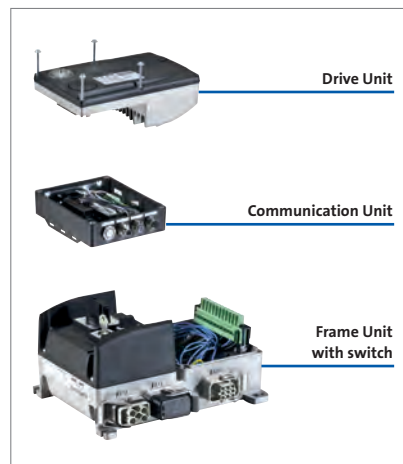

8400 motec field package with switch  
0.37 ... 3.0 kW

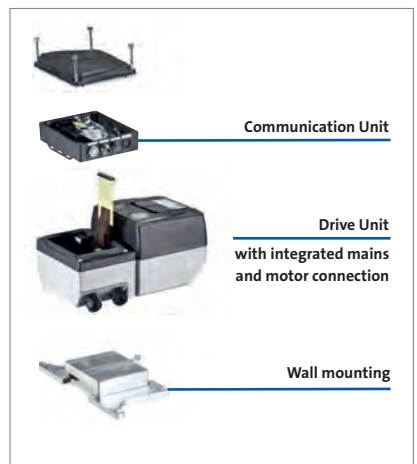

8400 motec field package without switch  
4.0 ... 7.5 kW



# Inverter Drives 8400 motec

## General information



### Drive Unit

On the underside of the drive unit, there is the power section. Here, there are also several DIP switches and potentiometers that enable configuration, speed and ramp settings to be made. In this way, the drive unit can be quickly and easily matched to the equipment in question.

For the purpose of diagnostics, you can plug in a diagnostic adapter alongside the status display without having to remove the drive. Thanks to the potentiometer that can be accessed from above, you can make speed settings while the motor is actually running.



DIP switches on Drive Unit



Diagnostic terminal Drive Unit



Diagnostic terminal Drive Unit

# Inverter Drives 8400 motec

## General information



### Functions and features

<b>Mode</b>	8400 motec
<b>Control mode, motor control</b>	
Sensorless vector control (SLVC)	For three-phase asynchronous motors
V/f control (VFCplus)	For three-phase AC motors and asynchronous servo motor (linear or square-law)
Energy saving function (VFC eco)	For three-phase asynchronous motors
<b>Basic functions</b>	<ul style="list-style-type: none"> <li>Freely assignable user menu</li> <li>Parameter change-over</li> <li>DC-injection braking function</li> <li>Flying restart circuit</li> <li>S-ramps for smooth acceleration</li> <li>PID controller</li> <li>3 fixed frequencies</li> <li>Skip frequencies</li> </ul>
<b>Technology applications</b>	<ul style="list-style-type: none"> <li>Speed actuating drive</li> <li>Switch-off positioning without feedback</li> </ul>
<b>Monitoring and protective measures</b>	<ul style="list-style-type: none"> <li>Short circuit</li> <li>Earth fault</li> <li>Overvoltage</li> <li>Motor phase failure</li> <li>Overcurrent</li> <li>I<sup>2</sup> x t motor monitoring</li> <li>Motor overtemperature</li> <li>Mains phase failure</li> <li>Protection for cyclic mains switching</li> <li>Motor stalling</li> </ul>
<b>Diagnostics</b>	Data logger, logbook
Status display	1 LED
Diagnostic interface	Integrated For USB diagnostic adapter or keypad (hand terminal)
<b>Braking operation</b>	
Brake chopper	Integrated
Brake resistor	Built-on module or external



### Operating modes

An inverter enables energy-efficient operation of a system in virtually all application cases. The various operating modes, which can be created by making just a few simple settings, facilitate this. The following characteristics and corresponding technical specifications listed on the following pages can be used to calculate the optimum operating mode during the project planning phase.

#### Standard setting

In its initial state when delivered, the inverter is set up for basic operation with a three-phase AC motor with V/f control. When operated in this mode, the rated torque of the motor is available in a setting range up to 50 Hz.

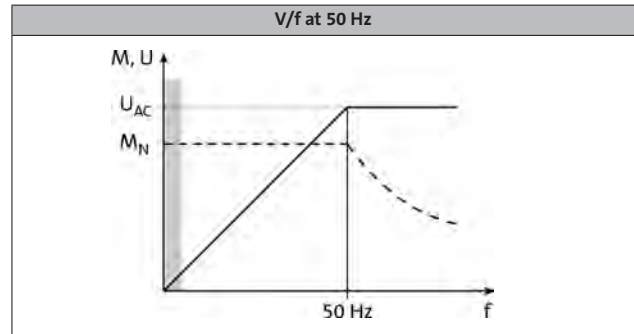

#### Extended setting range up to 87 Hz

If the V/f switchover point on the inverter is set to 87 Hz, the rated torque can be used across an extended setting range. Here, an e.g. 230/400 V motor is used and operated in a delta layout with a 400 V inverter. The setting range is then increased by 40 %. The inverter must be dimensioned for a rated motor current of 230 V.

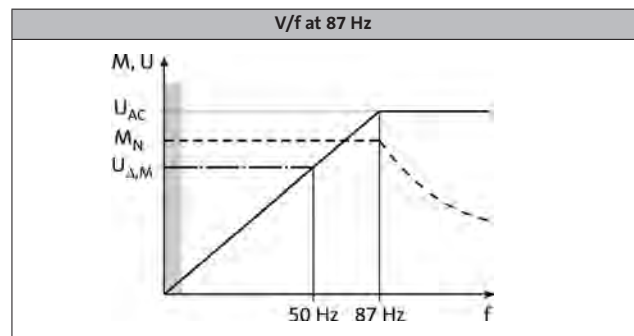

4.2

#### Operation with inverter-optimised MF motors

Large setting ranges and optimum operation at the rated torque: these are the strengths of the MF motor when used in combination with an inverter. The motors are optimised for a setting range up to 120 Hz. Compared to conventional 50 Hz operation, the setting range increases by 250 %. It is quite simply not possible for a drive to be operated any more efficiently in a machine.

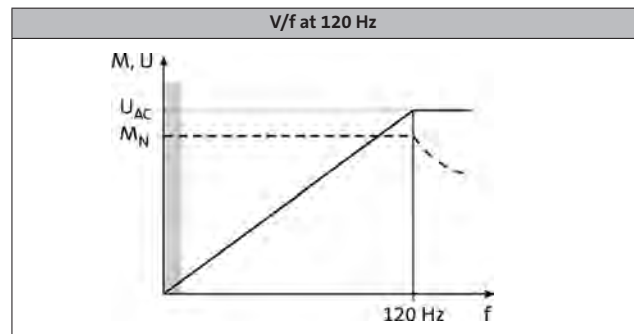

#### Operation with low loads

This operating mode can be used for various applications, e.g. for fans and pumps:

In fan and pump applications, the load behaviour follows a square-law characteristic depending on the speed. Often, an overload capacity of 1.2 x is sufficient. This serves to operate the inverter during operation with increased power, i.e. the inverter can be dimensioned one power size smaller. The square-law characteristic which corresponds to the load behaviour can be set in the inverter.

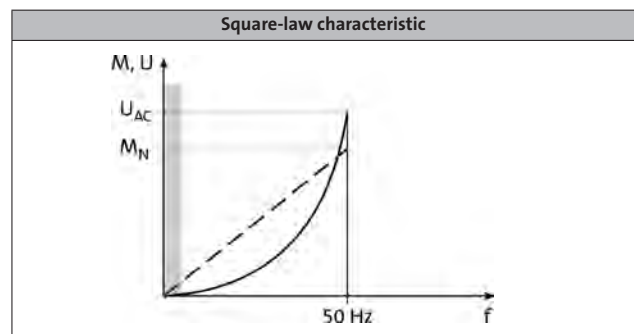



### Operating modes

#### Energy saving mode VFC-eco

The Inverter Drives 8400 make energy saving especially easy with the "VFC eco" function. Particularly in the partial load operational range, this function significantly reduces energy demand. Combined with the new L-force MF three-phase AC motors, this drive solution impresses with the maximum energy efficiency of a Lenze BlueGreen solution.

The "VFC eco" mode adapts the magnetising current of a motor intelligently to meet actual needs. This is particularly useful in partial load operational range as this is precisely where three-phase AC motors need to be supplied with a greater magnetising current than the operating conditions actually require. The "VFC eco" mode allows losses to be reduced so much that savings of up to 30 per cent can be achieved.

Energy efficiency can then be increased even further with the MF three-phase AC motors. These motors have been specifically designed for operation with frequency inverters. They operate at 120 Hz instead of 50 Hz, as 4-pole three-phase AC motors are at their most efficient at this frequency.

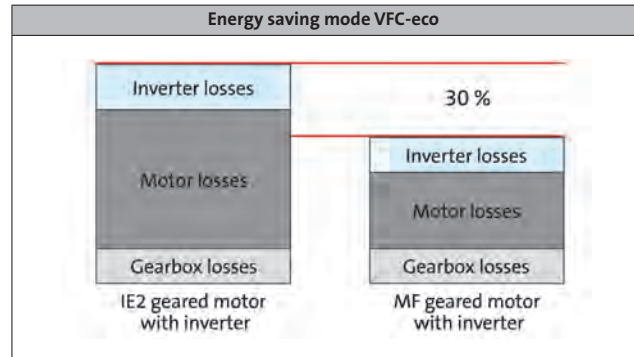

#### Overcurrent operation

The inverters can be driven at higher amperages beyond the rated current if the duration of this overcurrent operation is time limited. Two utilisation cycles with a duration of 15 s and 180 s are defined. Within these utilisation cycles, an overcurrent is possible for a certain time if afterwards an accordingly long recovery phase takes place. For both utilisation cycles, a moving average is determined separately. The adjacent diagram shows both cycles: 15 s in red and 180 s in blue. The overload times are 3 s (T1) and 60 s (T3) respectively, the corresponding recovery times are 12 s (T2) and 120 s (T4) respectively. The following tables show the resulting maximum output currents.

Monitoring of the device utilisation ( $I \times t$ ) activates the set error response (trip or warning) if one of the two utilisation values exceeds the threshold of 100 %.

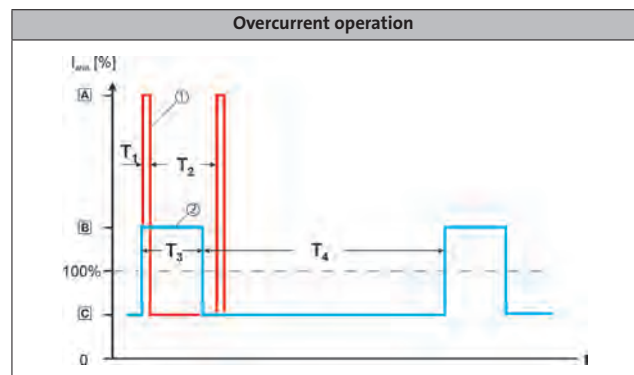

#### Switching frequencies

In the case of an inverter, the term "switching frequency" is understood to mean the frequency with which the output modules (inverters) are switched on and off.

The switching frequency on the 8400 motec can be set to values between 4 and 16 kHz; the selection depends on the output. Since losses in the form of heat can be generated when switching the modules, the inverter can provide a higher output current at a switching frequency of 2 kHz.

In addition to this, it is also important to differentiate between operation at a fixed switching frequency and a variable switching frequency, whereby the switching frequency is automatically reduced based on the output current here. The data for operation at increased output is permitted for operation at a switching frequency of 2 or 4 kHz and at an ambient temperature of max. 40 °C.

# Inverter Drives 8400 motec

Project planning



## Topologies for decentralised drive technology

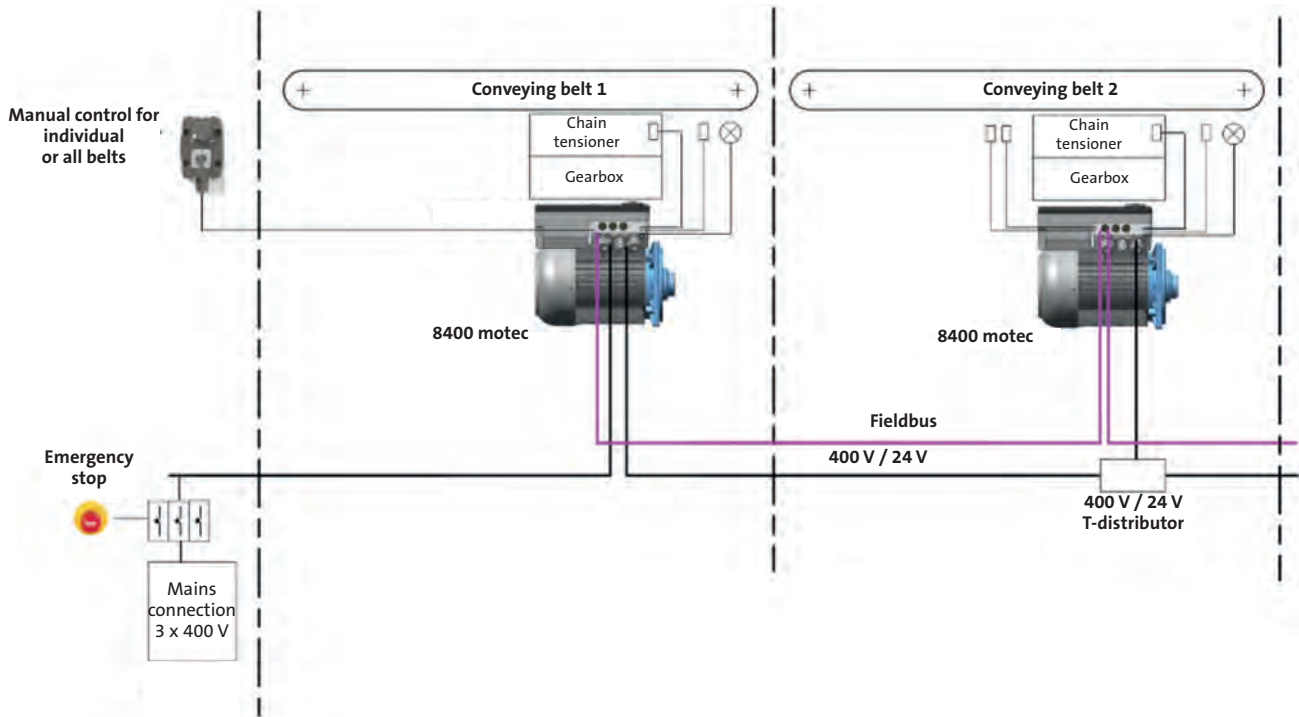

4.2

## Extension of safety technology

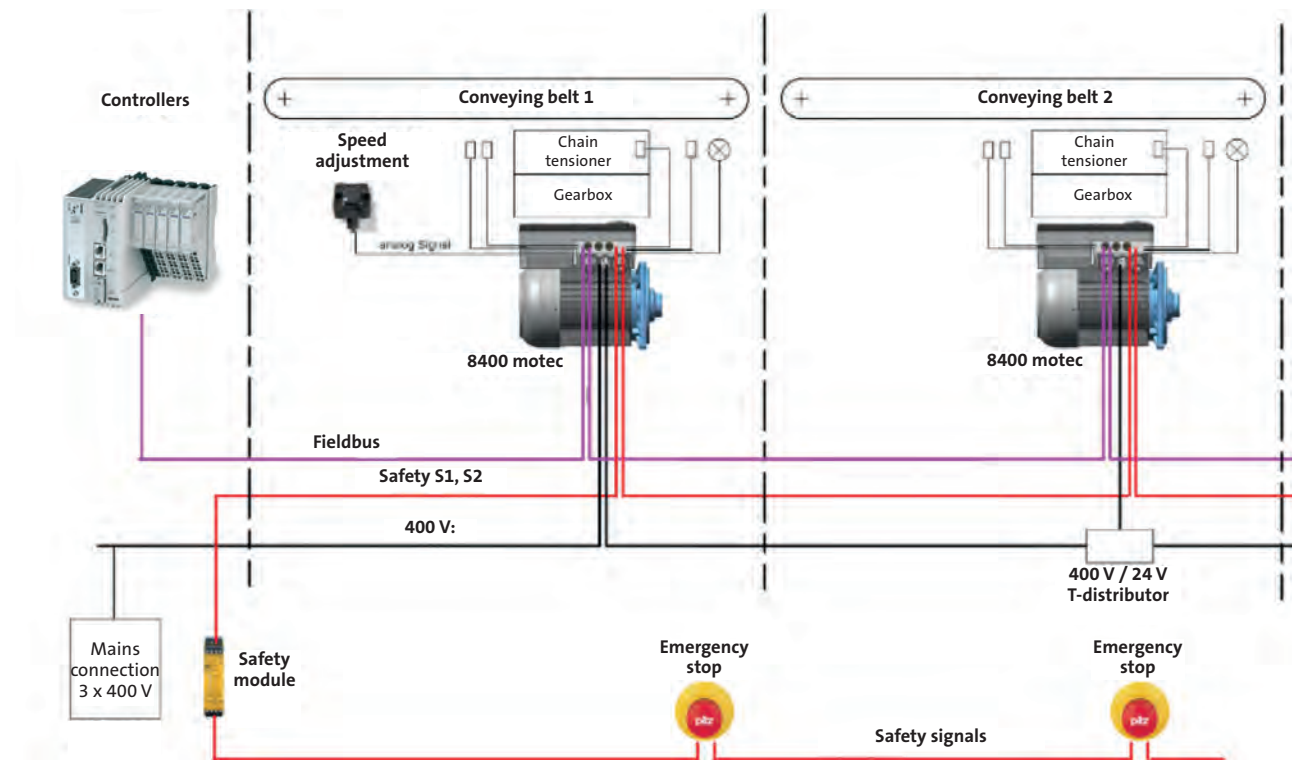

# Inverter Drives 8400 motec

## Project planning



### Application example whole system

Lenze components can be used to create an entire compact decentralised drive solution within the overall interconnected system.

#### Mains operation:

The IE1, IE2 and IE3 three-phase geared motors and the Lenze Smart Motor m300 in combination with the g500 gearboxes.

#### Inverter operation:

The various three-phase geared motors in combination with the 8400 motec inverter for motor and wall mounting and the 8400 protec for wall mounting.

Easy and clear wiring via terminal boxes or plug-in connectors ensure safe operation and a high level of service safety.

4.2

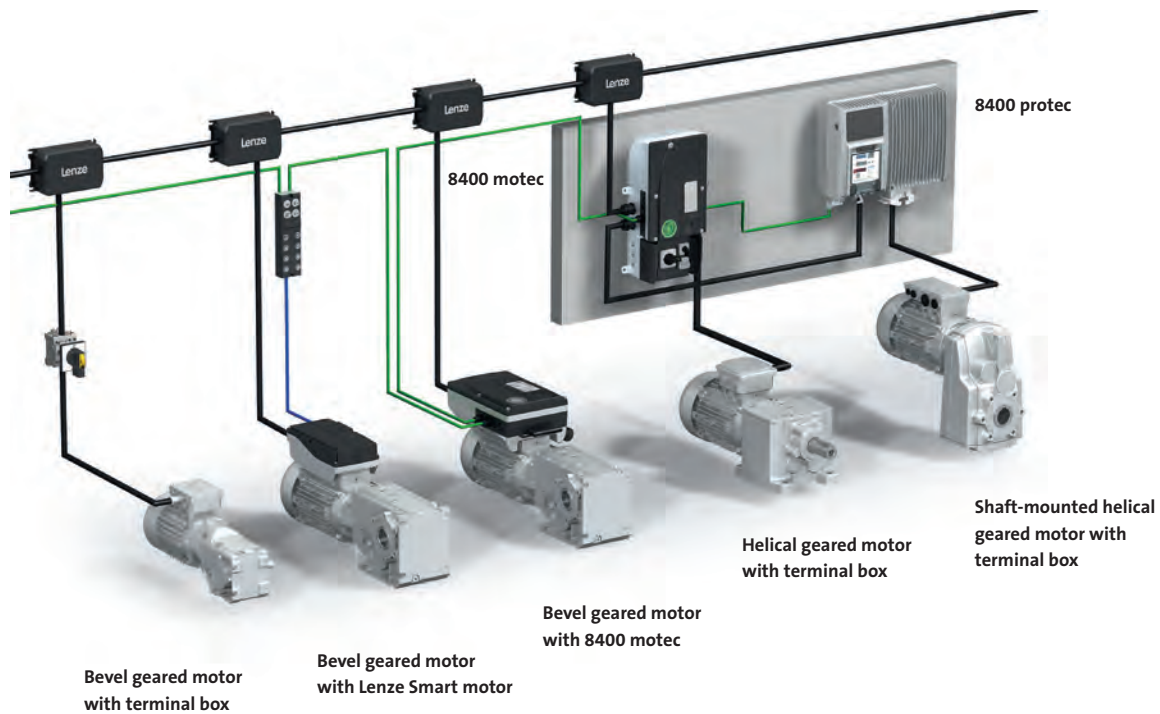

# Inverter Drives 8400 motec

Technical data



## Standards and operating conditions

<b>Mode</b>			
Product			8400 motec
<b>Conformity</b>			
CE			Low-Voltage Directive 2014/35/EU EMC Directive 2014/30/EU
EAC			TP TC 004/2011 (TR ZU 004/2011) TP TC 020/2011 (TR ZU 020/2011)
<b>Approval</b>			
UL 508C			Power Conversion Equipment (File-No. E132659/E170350)
CSA			CSA 22.2 No. 247-13
<b>Degree of protection</b>			
EN 60529			IP65 <sup>1)</sup>
NEMA 250			Type 4, Field Package 0.37 kW ... 3 kW type 12
<b>Climatic conditions</b>			
Storage (EN 60721-3-1)			1K3 (temperature: -30 °C ... +60 °C)
Transport (EN 60721-3-2)			2K3 (temperature: -30 °C ... +75 °C)
Operation (EN 60721-3-3) 3K3			3K3 (temperature: -30 °C ... +55 °C)
Current derating			2.5% / K Operation at 4 kHz above 45°C Operation at 8/16 kHz above 40°C
<b>Site altitude</b>			
Amsl	H <sub>max</sub>	[m]	4000
Current derating at over 1000 m		[%/1000 m]	5
<b>Vibration resistance</b>			
Transport (EN 60721-3-2)			2M2
Operation (EN 60721-3-3)			3M6
Operation (Germanischer Lloyd)			General conditions: Acceleration resistant up to 2 g

4.2

<b>Mode</b>			
Product			8400 motec
<b>Mains type</b>			
			Systems with earthed star point (TN and TT systems) Systems with high-resistance or isolated star point (IT systems)
<b>Noise emission</b>			
EN 61800-3			Integrated radio interference suppression measures: conducted, category C1 <sup>2)</sup> Wall mounting: category C2 with a shielded motor cable of up to 20 m when Fch = 4 kHz
<b>Insulation resistance</b>			
EN 61800-5-1			0 to 2000 m above sea level, overvoltage category III 2000 m to 4000 m above sea level, overvoltage category II
<b>Degree of pollution</b>			
EN 61800-5-1			2
<b>Protective insulation of control circuits</b>			
EN 61800-5-1			Safe mains isolation: double/reinforced insulation

<sup>1)</sup> Not with connector or brake resistor modules or Frame Unit with switch (IP54).

<sup>2)</sup> Applies to 4 kHz, from 4 kW category C2 for 4 and 8 kHz.

# Inverter Drives 8400 motec

Technical data



## Rated data 400 V

- The data applies to operation at 400 V AC.
- Unless otherwise specified, the data refers to the default setting.
- The product key of the inverter for motor mounting is specified in the technical data tables.
- For wall mounting of devices up to 3 kW, the corresponding derating data in the hardware manual must be observed.

<b>Typical motor power</b>						
4-pole asynchronous motor	P	[kW]	0.37	0.55 <sup>1)</sup>	0.55	0.75 <sup>1)</sup>
<b>Product key</b>						
Drive Unit			E84DGDVB37142PS		E84DGDVB55142PS	
Motor mounting set			E84DVBM3714□□□□2□□		E84DVBM5514□□□□2□□	
Field package			Z□5□□□□□□□□□□137□□□□		Z□5□□□□□□□□□□155□□□□	
<b>Mains voltage range</b>						
	U <sub>AC</sub>	[V]	3/PE AC 320 V-0 % ... 528 V+0 %, 45 Hz-0 % ... 65 Hz+0 %			
<b>Rated mains current</b>						
	I <sub>N, AC</sub>	[A]	1.3	1.6	1.8	2.2
<b>Rated output current</b>						
	I <sub>N, out</sub>	[A]	1.3	1.6	1.8	2.2
<b>Rated switching frequency</b>						
	f <sub>ch</sub>	[kHz]	8	4	8	4
<b>Output current</b>						
4 kHz	I <sub>out</sub>	[A]	1.3	1.6	1.8	2.2
8 kHz	I <sub>out</sub>	[A]	1.3		1.8	
16 kHz	I <sub>out</sub>	[A]	0.9		1.2	

## Data for 60 s overload

<b>Max. output current</b>				
	I <sub>max, out</sub>	[A]	2.0	2.7
<b>Overload time</b>				
	t <sub>ol</sub>	[s]	60.0	
<b>Recovery time</b>				
	t <sub>re</sub>	[s]	120.0	

## Data for 3 s overload

<b>Max. short-time output current</b>				
	I <sub>max, out</sub>	[A]	2.6	3.6
<b>Overload time</b>				
	t <sub>ol</sub>	[s]	3.0	
<b>Recovery time</b>				
	t <sub>re</sub>	[s]	12.0	

<sup>1)</sup> Operating mode with increased rated power at 40°C ambient temperature and mains voltage of 400 V AC



# Inverter Drives 8400 motec

Technical data



## Rated data 400 V

- The data applies to operation at 400 V AC.
- Unless otherwise specified, the data refers to the default setting.
- The product key of the inverter for motor mounting is specified in the technical data tables.
- For wall mounting of devices up to 3 kW, the corresponding derating data in the hardware manual must be observed.

<b>Typical motor power</b>						
4-pole asynchronous motor	P	[kW]	0.37	0.55 <sup>1)</sup>	0.55	0.75 <sup>1)</sup>
<b>Product key</b>						
Drive Unit			E84DGDVB37142PS		E84DGDVB55142PS	
Motor mounting set			E84DVBM3714□□□□2□□		E84DVBM5514□□□□2□□	
Field package			z□5□□□□□□□□□□137□□□□		z□5□□□□□□□□□□155□□□□	
<b>Power loss</b>						
	P <sub>V</sub>	[kW]	0.026		0.033	
<b>Mass</b>						
	m	[kg]	2.6			
<b>Max. cable length</b>						
shielded motor cable <sup>2)</sup>	l <sub>max</sub>	[m]	20			

4.2

## Brake chopper rated data

<b>Rated power, Brake chopper</b>						
	P <sub>N</sub>	[kW]	0.4	0.5	0.6	0.7
<b>Max. output power, Brake chopper</b>						
	P <sub>max, 1</sub>	[kW]	0.6		0.8	
<b>Min. brake resistance</b>						
	R <sub>min</sub>	[Ohm]	90.0			

## Dimensions

<b>Dimensions</b>						
Height	h	[mm]	109			
Width	b	[mm]	161			
Depth	t	[mm]	241			

<sup>1)</sup> Operating mode with increased rated power at 40 °C ambient temperature and max. mains voltage of 400 V AC

<sup>2)</sup> Technically possible cable lengths, irrespective of EMC requirements

# Inverter Drives 8400 motec

Technical data



## Rated data 400 V

- The data applies to operation at 400 V AC.
- Unless otherwise specified, the data refers to the default setting.
- The product key of the inverter for motor mounting is specified in the technical data tables.
- For wall mounting of devices up to 3 kW, the corresponding derating data in the hardware manual must be observed.

<b>Typical motor power</b>							
4-pole asynchronous motor		P	[kW]	0.75	1.10 <sup>1)</sup>	1.10	1.50 <sup>1)</sup>
<b>Product key</b>							
Drive Unit				E84DGDVB75142PS		E84DGDVB11242PS	
Motor mounting set				E84DVBM7514□□□□2□□		E84DVBM1124□□□□2□□	
Field package				Z□5□□□□□□□□□□175□□□□		Z□5□□□□□□□□□□211□□□□	
<b>Mains voltage range</b>							
	U <sub>AC</sub>	[V]		3/PE AC 320 V-0 % ... 528 V+0 %, 45 Hz-0 % ... 65 Hz+0 %			
<b>Rated mains current</b>							
	I <sub>N, AC</sub>	[A]		2.4	3.0	3.2	3.8
<b>Rated output current</b>							
	I <sub>N, out</sub>	[A]		2.4	3.0	3.2	3.8
<b>Rated switching frequency</b>							
	f <sub>ch</sub>	[kHz]		8	4	8	4
<b>Output current</b>							
4 kHz	I <sub>out</sub>	[A]		2.4	3.0	3.2	3.8
8 kHz	I <sub>out</sub>	[A]		2.4		3.2	
16 kHz	I <sub>out</sub>	[A]		1.6		2.1	

## Data for 60 s overload

<b>Max. output current</b>					
	I <sub>max, out</sub>	[A]		3.6	4.8
<b>Overload time</b>				60.0	
	t <sub>ol</sub>	[s]		60.0	
<b>Recovery time</b>				120.0	
	t <sub>re</sub>	[s]		120.0	

## Data for 3 s overload

<b>Max. short-time output current</b>					
	I <sub>max, out</sub>	[A]		4.8	6.4
<b>Overload time</b>				3.0	
	t <sub>ol</sub>	[s]		3.0	
<b>Recovery time</b>				12.0	
	t <sub>re</sub>	[s]		12.0	

<sup>1)</sup> Operating mode with increased rated power at 40 °C ambient temperature and max. mains voltage of 400 V AC

# Inverter Drives 8400 motec

Technical data



## Rated data 400 V

- The data applies to operation at 400 V AC.
- Unless otherwise specified, the data refers to the default setting.
- The product key of the inverter for motor mounting is specified in the technical data tables.
- For wall mounting of devices up to 3 kW, the corresponding derating data in the hardware manual must be observed.

<b>Typical motor power</b>					
4-pole asynchronous motor	P	[kW]	0.75	1.10 <sup>1)</sup>	1.10   1.50 <sup>1)</sup>
<b>Product key</b>					
Drive Unit		E84DGDVB75142PS		E84DGDVB11242PS	
Motor mounting set		E84DVBM7514□□□□2□□		E84DVBM1124□□□□2□□	
Field package		Z□5□□□□□□□□□□175□□□□		Z□5□□□□□□□□□□211□□□□	
<b>Power loss</b>					
	P <sub>V</sub>	[kW]	0.041		0.052
<b>Mass</b>					
	m	[kg]	2.6		
<b>Max. cable length</b>					
shielded motor cable <sup>2)</sup>	l <sub>max</sub>	[m]	20		

4.2

## Brake chopper rated data

<b>Rated power, Brake chopper</b>					
	P <sub>N</sub>	[kW]	0.8	0.9	1.1   1.3
<b>Max. output power, Brake chopper</b>					
	P <sub>max,1</sub>	[kW]	1.3		1.7
<b>Min. brake resistance</b>					
	R <sub>min</sub>	[Ohm]	90.0		

## Dimensions

<b>Dimensions</b>			
Height	h	[mm]	109
Width	b	[mm]	161
Depth	t	[mm]	241

<sup>1)</sup> Operating mode with increased rated power at 40 °C ambient temperature and max. mains voltage of 400 V AC

<sup>2)</sup> Technically possible cable lengths, irrespective of EMC requirements

# Inverter Drives 8400 motec

Technical data



## Rated data 400 V

- The data applies to operation at 400 V AC.
- Unless otherwise specified, the data refers to the default setting.
- The product key of the inverter for motor mounting is specified in the technical data tables.
- For wall mounting of devices up to 3 kW, the corresponding derating data in the hardware manual must be observed.

							
<b>Typical motor power</b>							
4-pole asynchronous motor		P	[kW]	1.50	2.20 <sup>1)</sup>	2.20	3.00 <sup>1)</sup>
<b>Product key</b>							
Drive Unit				E84DGDVB15242PS		E84DGDVB22242PS	
Motor mounting set				E84DVBM1524□□□2□□		E84DVBM22245□□□2□□	
Field package				Z□5□□□□□□□□□215□□□□		Z□5□□□□□□□□□222□□□□	
<b>Mains voltage range</b>							
	U <sub>AC</sub>	[V]	3/PE AC 320 V-0 % ... 528 V+0 %, 45 Hz-0 % ... 65 Hz+0 %				
<b>Rated mains current</b>							
	I <sub>N, AC</sub>	[A]	3.8	4.6	5.6	7.0	
<b>Rated output current</b>							
	I <sub>N, out</sub>	[A]	3.9	4.8	5.6	7.0	
<b>Rated switching frequency</b>							
	f <sub>ch</sub>	[kHz]	8	4	8	4	
<b>Output current</b>							
4 kHz	I <sub>out</sub>	[A]	3.9	4.8	5.6	7	
8 kHz	I <sub>out</sub>	[A]	3.9		5.6		
16 kHz	I <sub>out</sub>	[A]	2.6		3.7		

## Data for 60 s overload

<b>Max. output current</b>					
	I <sub>max, out</sub>	[A]	5.9	8.4	
<b>Overload time</b>					
	t <sub>ol</sub>	[s]	60.0		
<b>Recovery time</b>					
	t <sub>re</sub>	[s]	120.0		

## Data for 3 s overload

<b>Max. short-time output current</b>					
	I <sub>max, out</sub>	[A]	7.8	11.2	
<b>Overload time</b>					
	t <sub>ol</sub>	[s]	3.0		
<b>Recovery time</b>					
	t <sub>re</sub>	[s]	12.0		

<sup>1)</sup> Operating mode with increased rated power at 40°C ambient temperature and max. mains voltage of 400 V AC. Operation with 2.2 kW is not permitted with the field package.

# Inverter Drives 8400 motec

Technical data



## Rated data 400 V

- The data applies to operation at 400 V AC.
- Unless otherwise specified, the data refers to the default setting.
- The product key of the inverter for motor mounting is specified in the technical data tables.
- For wall mounting of devices up to 3 kW, the corresponding derating data in the hardware manual must be observed.

<b>Typical motor power</b>						
4-pole asynchronous motor	P	[kW]	1.50	2.20 <sup>1)</sup>	2.20	3.00 <sup>1)</sup>
<b>Product key</b>						
Drive Unit			E84DGDVB15242PS		E84DGDVB22242PS	
Motor mounting set			E84DVBM1524□□□2□□		E84DVBM2224□□□2□□	
Field package			Z□5□□□□□□□□215□□□□		Z□5□□□□□□□□222□□□□	
<b>Power loss</b>						
	P <sub>V</sub>	[kW]	0.061		0.088	
<b>Mass</b>						
	m	[kg]	2.6		3.5	
<b>Max. cable length</b>						
shielded motor cable <sup>2)</sup>	l <sub>max</sub>	[m]	20			

4.2

## Brake chopper rated data

<b>Rated power, Brake chopper</b>						
	P <sub>N</sub>	[kW]	1.5	1.8	2.2	2.6
<b>Max. output power, Brake chopper</b>						
	P <sub>max, 1</sub>	[kW]	2.3		3.3	
<b>Min. brake resistance</b>						
	R <sub>min</sub>	[Ohm]	90.0		90.0	

## Dimensions

<b>Dimensions</b>				
Height	h	[mm]	109	135
Width	b	[mm]	161	176
Depth	t	[mm]	241	261

<sup>1)</sup> Operating mode with increased rated power at 40°C ambient temperature and max. mains voltage of 400 V AC. Operation with 2.2 kW is not permitted with the field package.

<sup>2)</sup> Technically possible cable lengths, irrespective of EMC requirements



# Inverter Drives 8400 motec

Technical data



## Rated data 400 V

- The data applies to operation at 400 V AC.
- Unless otherwise specified, the data refers to the default setting.
- The product key of the inverter for motor mounting is specified in the technical data tables.
- For wall mounting of devices up to 3 kW, the corresponding derating data in the hardware manual must be observed.

						
<b>Typical motor power</b>						
4-pole asynchronous motor	P	[kW]	3.00	4.00 <sup>1)</sup>	4.00	5.50 <sup>1)</sup>
<b>Product key</b>						
Drive Unit			E84DGDVB30242PS		E84DGDVB40242PS	
Motor mounting set			E84DVBM3024□□□2□□		E84DVBM40242□□□2□□	
Field package			Z□5□□□□□□□□230□□□□		Z□5□□□□□□□□240□□□□	
<b>Mains voltage range</b>						
	U <sub>AC</sub>	[V]	3/PE AC 320 V-0 % ... 528 V+0 %, 45 Hz-0 % ... 65 Hz+0 %			
<b>Rated mains current</b>						
	I <sub>N, AC</sub>	[A]	7.2	8.6	9.3	11.3
<b>Rated output current</b>						
	I <sub>N, out</sub>	[A]	7.3	8.7	9.5	11.6
<b>Rated switching frequency</b>						
	f <sub>ch</sub>	[kHz]	8	4	8	4
<b>Output current</b>						
4 kHz	I <sub>out</sub>	[A]	7.3	8.7	9.5	11.6
8 kHz	I <sub>out</sub>	[A]	7.3		9.5	
16 kHz	I <sub>out</sub>	[A]	4.9		6.3	

## Data for 60 s overload

<b>Max. output current</b>	I <sub>max, out</sub>	[A]	11.0	14.3
<b>Overload time</b>	t <sub>ol</sub>	[s]	60.0	
<b>Recovery time</b>	t <sub>re</sub>	[s]	120.0	

## Data for 3 s overload

<b>Max. short-time output current</b>	I <sub>max, out</sub>	[A]	14.6	19.0
<b>Overload time</b>	t <sub>ol</sub>	[s]	3.0	
<b>Recovery time</b>	t <sub>re</sub>	[s]	12.0	

<sup>1)</sup> Operating mode with increased rated power at 40°C ambient temperature and max. mains voltage of 400 V AC. The field package is not available with 4.0 kW.



# Inverter Drives 8400 motec

Technical data



## Rated data 400 V

- The data applies to operation at 400 V AC.
- Unless otherwise specified, the data refers to the default setting.
- The product key of the inverter for motor mounting is specified in the technical data tables.
- For wall mounting of devices up to 3 kW, the corresponding derating data in the hardware manual must be observed.

						
<b>Typical motor power</b>						
4-pole asynchronous motor	P	[kW]	3.00	4.00 <sup>1)</sup>	4.00	5.50 <sup>1)</sup>
<b>Product key</b>						
Drive Unit			E84DGDVB30242PS		E84DGDVB40242PS	
Motor mounting set			E84DVBM3024□□□2□□		E84DVBM40242□□□2□□	
Field package			Z□5□□□□□□□□230□□□□		Z□5□□□□□□□□240□□□□	
<b>Power loss</b>						
	P <sub>V</sub>	[kW]	0.11		0.14	
<b>Mass</b>						
	m	[kg]	3.5		5.3	
<b>Max. cable length</b>						
shielded motor cable <sup>2)</sup>	l <sub>max</sub>	[m]			20	

4.2

## Brake chopper rated data

<b>Rated power, Brake chopper</b>				
	P <sub>N</sub>	[kW]	3.0	4.0
<b>Max. output power, Brake chopper</b>				
	P <sub>max, 1</sub>	[kW]	4.5	5.5
<b>Min. brake resistance</b>				
	R <sub>min</sub>	[Ohm]	90.0	47.0

## Dimensions

Dimensions				
Height	h	[mm]	135	176
Width	b	[mm]	176	195
Depth	t	[mm]	261	325

<sup>1)</sup> Operating mode with increased rated power at 40°C ambient temperature and max. mains voltage of 400 V AC. The field package is not available with 4.0 kW.

<sup>2)</sup> Technically possible cable lengths, irrespective of EMC requirements

# Inverter Drives 8400 motec

Technical data



## Rated data 400 V

- The data applies to operation at 400 V AC.
- Unless otherwise specified, the data refers to the default setting.
- The product key of the inverter for motor mounting is specified in the technical data tables.
- For wall mounting of devices up to 3 kW, the corresponding derating data in the hardware manual must be observed.

<b>Typical motor power</b>						
4-pole asynchronous motor	P	[kW]	5.50	7.50 <sup>1)</sup>	7.50	9.20 <sup>1)</sup>
<b>Product key</b>						
Drive Unit			E84DGDVB55242PS		E84DGDVB75242PS	
Motor mounting set			E84DVBM5524□□□2□□		E84DVBM7524□□□2□□	
Field package			Z□5□□□□□□□□□255□□□□		Z□5□□□□□□□□□275□□□□	
<b>Mains voltage range</b>			3/PE AC 320 V-0 % ... 528 V+0 %, 45 Hz-0 % ... 65 Hz+0 %			
	U <sub>AC</sub>	[V]				
<b>Rated mains current</b>						
	I <sub>N, AC</sub>	[A]	12.8	15.3	16.3	19.5
<b>Rated output current</b>						
	I <sub>N, out</sub>	[A]	13.0	15.6	16.5	19.8
<b>Rated switching frequency</b>						
	f <sub>ch</sub>	[kHz]	8	4	8	4
<b>Output current</b>						
4 kHz	I <sub>out</sub>	[A]	13.0	15.6	16.5	19.8
8 kHz	I <sub>out</sub>	[A]	13.0		16.5	
16 kHz	I <sub>out</sub>	[A]	8.7		11.0	

### Data for 60 s overload

<b>Max. output current</b>					
	I <sub>max, out</sub>	[A]	19.5		24.7
<b>Overload time</b>					
	t <sub>ol</sub>	[s]		60.0	
<b>Recovery time</b>					
	t <sub>re</sub>	[s]		120.0	

### Data for 3 s overload

<b>Max. short-time output current</b>					
	I <sub>max, out</sub>	[A]	26.0		33.0
<b>Overload time</b>					
	t <sub>ol</sub>	[s]		3.0	
<b>Recovery time</b>					
	t <sub>re</sub>	[s]		12.0	

<sup>1)</sup> Operating mode with increased rated power at 40°C ambient temperature and max. mains voltage of 400 V AC. Operation with 9.2 kW is not permitted with the Q8 connector.



# Inverter Drives 8400 motec

Technical data



## Rated data 400 V

- The data applies to operation at 400 V AC.
- Unless otherwise specified, the data refers to the default setting.
- The product key of the inverter for motor mounting is specified in the technical data tables.
- For wall mounting of devices up to 3 kW, the corresponding derating data in the hardware manual must be observed.

<b>Typical motor power</b>						
4-pole asynchronous motor	P	[kW]	5.50	7.50 <sup>1)</sup>	7.50	9.20 <sup>1)</sup>
<b>Product key</b>						
Drive Unit			E84DGDVB55242PS		E84DGDVB75242PS	
Motor mounting set			E84DVBM5524□□□2□□		E84DVBM7524□□□2□□	
Field package			Z□5□□□□□□□□255□□□□		Z□5□□□□□□□□275□□□□	
<b>Power loss</b>						
	P <sub>V</sub>	[kW]	0.18		0.23	
<b>Mass</b>						
	m	[kg]	5.3			
<b>Max. cable length</b>						
shielded motor cable <sup>2)</sup>	l <sub>max</sub>	[m]	20			

4.2

## Brake chopper rated data

<b>Rated power, Brake chopper</b>						
	P <sub>N</sub>	[kW]	5.5	6.6	7.5	9.2
<b>Max. output power, Brake chopper</b>						
	P <sub>max, 1</sub>	[kW]	7.5		9.2	
<b>Min. brake resistance</b>						
	R <sub>min</sub>	[s]	47.0			

## Dimensions

<b>Dimensions</b>			
Height	h	[mm]	176
Width	b	[mm]	195
Depth	t	[mm]	325

<sup>1)</sup> Operating mode with increased rated power at 40°C ambient temperature and max. mains voltage of 400 V AC. Operation with 9.2 kW is not permitted with the Q8 connector.

<sup>2)</sup> Technically possible cable lengths, irrespective of EMC requirements

# Inverter Drives 8400 motec

Technical data



## Mains connection

- The data given for mains fuses and cable cross-sections is intended for a mains connection of 3 x 400 V for individual connection.
- Fuse of gG/gL utilisation category or semiconductor fuses of gRL utilisation category.
- The cable cross-sections apply to PVC-insulated copper cables.
- Use for installation with UL-approved cables, fuses and brackets.

Typical motor power	Mains voltage	Automatic circuit breaker	Fuse		Mains connection
			EN 60204-1	UL	
4-pole asynchronous motor					Cross-section (without mains choke)
P	U <sub>AC</sub>	I	I	I	q
[kW]	[V]	[A]	[A]	[A]	[mm <sup>2</sup> ]
0.37	3 AC 320 ... 528	C16	16	15	2.5
0.55					
0.75					
1.10					
1.50					
2.20					
3.00					
4.00					
5.50					
7.50					
		C20	20	20	4.0

4.2

## Motor connection

- Keep motor cables as short as possible as this has a positive effect on the drive behaviour.
- With group drives (multiple motors on one inverter), the resulting cable length is the key factor. This can be calculated using the hardware manual.
- Electric strength of the motor cable: 1 kV according to VDE 250-1.

EMC			
Interference emission (in TN and TT networks)			
Cable-guided	EN 61800-3		
Motor mounting		0.37 ... 1.5 kW, $f_{ch} \leq 8$ kHz	Category C1
		2.2 ... 3.0 kW, $f_{ch} \leq 4$ kHz	Category C1
		4.0 ... 7.5 kW	Category C2
Wall mounting and Lenze system cable 20 m	EN 61800-3	0.37 ... 7.5 kW, $f_{ch} \leq 4$ kHz	Category C2
Wall mounting and Lenze system cable 10 m	EN 61800-3	0.37 ... 7.5 kW, $f_{ch} \leq 8$ kHz	Category C2
Radiation	EN 61800-3	0.37 ... 1.5 kW, $f_{ch} \leq 8$ kHz	Category C1
		2.2 ... 7.5 kW, $f_{ch} \leq 8$ kHz	Category C2

# Inverter Drives 8400 motec

Technical data



## Electrical installation

### Power connections

#### Basic circuit diagram

0.37 ... 3 kW

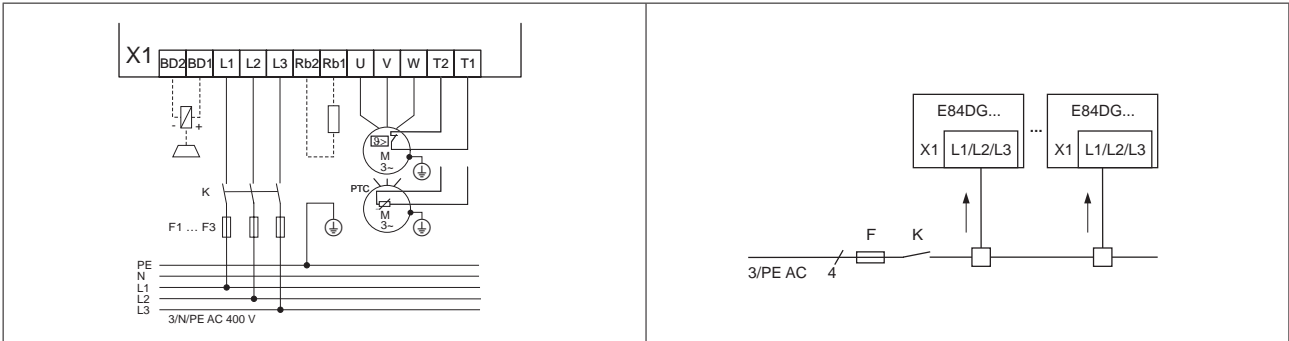

4 ... 7.5 kW



4.2



# Inverter Drives 8400 motec

## Module



### Communication Unit

The communication modules support the following functions:

- Control of inverters via digital and analogue signals
- Control of the inverter via the fieldbus systems
- Support for “safe torque off” functionality
- Connection options for sensors and actuators
- The sensors can be powered by the internal 24V supply
- Connection options via cable glands and M12 connectors. A total of up to 8 screwed connections / plugs can be used. Based on their function, the individual communication units are equipped with the corresponding connections as standard.



Communication Unit

	Controller enable	Digital inputs	Digital outputs	Relay outputs	Analogue inputs	Safety STO 2 channels (SIA and SIB)	External DC 24 V supply
	Number	Number	Number	Number	Number	Number	Number
<b>I/O module</b>							
Basic I/O	1	2		1			
Standard I/O	1	5	1	1	1		1
Extended I/O	1	8	1	1	2		
<b>Fieldbus</b>							
AS-Interface							
AS-Interface Enhanced	1	5	1				
CANopen							
CANopen Enhanced							
EtherCAT							
EtherCAT Enhanced							
EtherNet/IP							
EtherNet/IP Enhanced	1	5	1				1
PROFIBUS							
PROFIBUS Enhanced							
PROFINET							
PROFINET Enhanced							
<b>Fieldbus with safety</b>							
AS-Interface STO							
AS-Interface STO Enhanced							
CANopen STO							
CANopen STO Enhanced							
EtherCAT STO							
CAN STO Enhanced	1	5	1	1	1	1	1
EtherNet/IP STO							
EtherNet/IP STO Enhanced							
PROFIBUS STO							
PROFIBUS STO Enhanced							
PROFINET STO							
PROFINET STO Enhanced							

# Inverter Drives 8400 motec

Module



## General technical data

<b>Mode</b>	
Product	8400 motec
<b>Analog inputs</b>	
	Switchable: voltage or current input
Resolution	10 Bit
Value range	0 ... 10 V, 0/4 ... 20 mA
<b>Digital inputs</b>	
Switching level	SPS (IEC 61131-2)
Function	Parameterisable
<b>Digital outputs</b>	
Switching level	SPS (IEC 61131-2)
Max. output current	50 mA
Function	Parameterisable
<b>Relay</b>	
Contact	Normally-open contact
Connection	250 V AC, 3 A
Connection	24 V DC, 2 A ... 240 V, 0.16 A
Function	Parameterisable
<b>External 24 V DC supply</b>	
	To support communication when the 400 V is switched off
<b>Internal 24 V DC supply</b>	
	Max. 100 mA for inputs/outputs and sensor feeds
<b>Interfaces</b>	
Extensions	Fieldbus via Communication Unit
Safety technology	Dual-channel STO input
<b>Drive interface</b>	
Encoder input	via 2 digital inputs, HTL, 2-track, 10 kHz

4.2

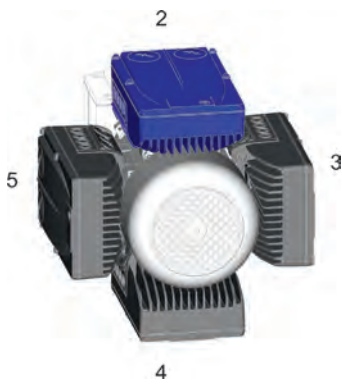

Terminal box position



Connection positions

## Connection designation

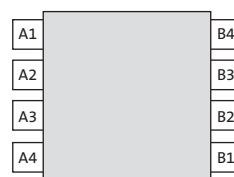

The basic design of the Communication Units includes standard positions for the M-12 connector. These can be seen in the respective data tables on the following pages.

# Inverter Drives 8400 motec

## Module



---

### Safety technology

The "safe torque off (STO)" safety function can be integrated into the Communication Unit in addition to the communication module. This combination is available with any fieldbus.

Communication module	AS-interface STO	CANopen STO	EtherCAT STO	EtherNet/IP STO	PROFIBUS STO	PROFINET STO
<b>Certification</b>						
EN ISO 13849-1						PLe Category 4
EN 61800-5-2						SIL 3
EN 62061						SIL 3
IEC 61508						SIL 3
<b>Fail-safe state</b>						
	Safe torque off					

# Inverter Drives 8400 motec

## Module



### Communication module without fieldbus link Basic I/Os

The Basic I/O function module provides the inverter with a minimum number of digital inputs and outputs for very simple applications.



Basic I/O communication module

#### Standards and operating conditions

<b>Degree of protection</b>				
EN 60529				IP65
<b>Climatic conditions</b>				
Storage (EN 60721-3-1)				1K3 (temperature: -30 °C ... +60 °C)
Operation (EN 60721-3-3)				3K3 (temperature: -30 °C ... +55 °C)
Transport (EN 60721-3-2)				2K3 (temperature: -30 °C ... +75 °C)
<b>Insulation voltage to reference earth/PE</b>				
EN 61800-5-1		U <sub>AC</sub>	[V]	50.0

4.2

#### Connections

Mode	Features		Connections	Cable glands (possible connections)	Product key								
Basic I/Os	Controller enable Digital inputs Relay	RFR TU NO	1 2 1	<table border="1"> <tr> <td>A1</td> <td>B4</td> </tr> <tr> <td>A2</td> <td>B3</td> </tr> <tr> <td>A3</td> <td>B2</td> </tr> <tr> <td>A4</td> <td>B1</td> </tr> </table>	A1	B4	A2	B3	A3	B2	A4	B1	E84DGFNNNP
A1	B4												
A2	B3												
A3	B2												
A4	B1												

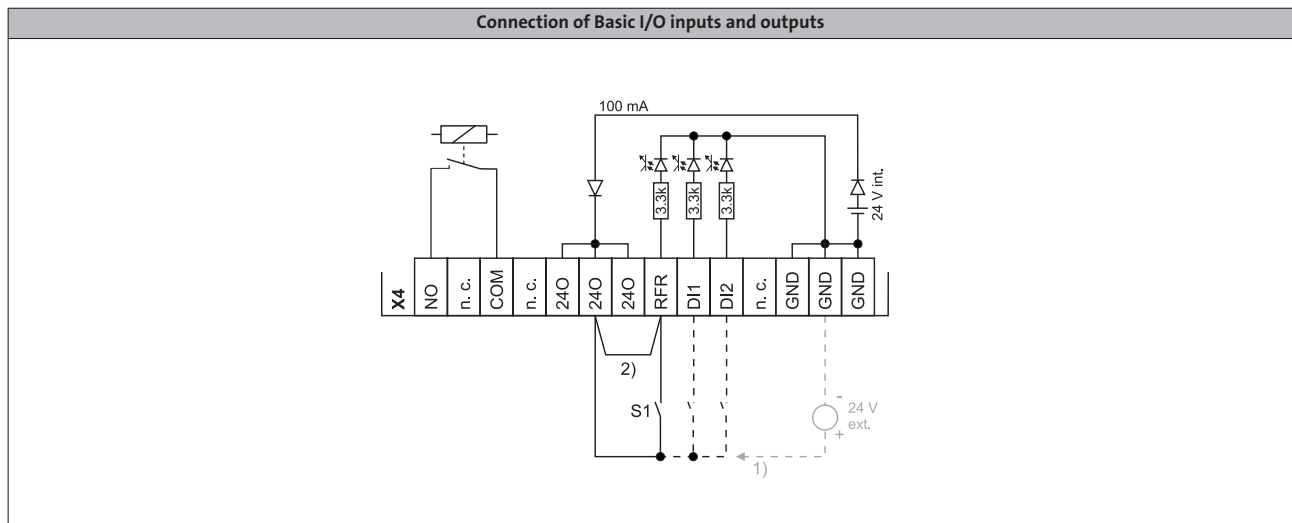

# Inverter Drives 8400 motec

Module



## Communication module without fieldbus link Standard I/O

The Standard I/O function module provides the inverter with a number of digital inputs and outputs and is primarily intended for standard applications.



Communication module Standard I/O

### Standards and operating conditions

<b>Degree of protection</b>			
EN 60529			IP65
<b>Climatic conditions</b>			
Storage (EN 60721-3-1)			1K3 (temperature: -30 °C ... +60 °C)
Operation (EN 60721-3-3)			3K3 (temperature: -30 °C ... +55 °C)
Transport (EN 60721-3-2)			2K3 (temperature: -30 °C ... +75 °C)
<b>Insulation voltage to reference earth/PE</b>			
EN 61800-5-1	U <sub>AC</sub>	[V]	50.0

4.2

### Connections

Mode	Features		Connections	Cable glands (possible connections)	Product key
Standard I/O	Controller enable Digital inputs Digital outputs Analog input Relay Safety function STO 24 V DC external	RFR TU DO AI NO STO 24 V	1 5 1 1 1 - -		E84DGFCSNNP

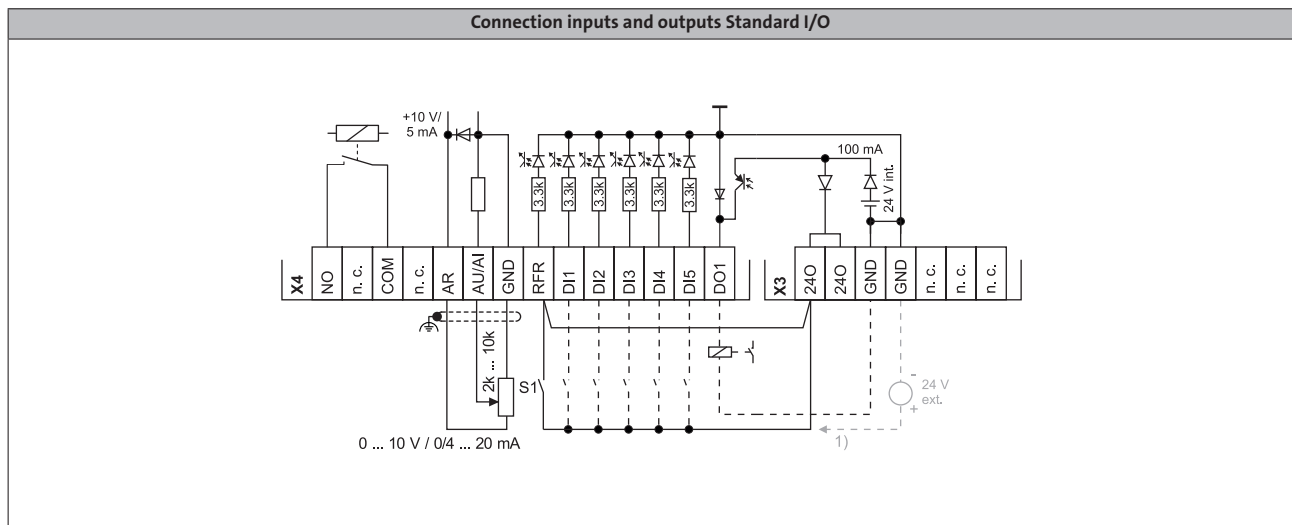



# Inverter Drives 8400 motec

Module



## Communication module without fieldbus link Extended I/O

The I/O function module Extended I/O provides the inverter with two additional digital inputs and one analog input over the Standard I/O and is intended for use with higher-order applications.



Communication module Extended I/O

### Standards and operating conditions

<b>Degree of protection</b>				
EN 60529				IP65
<b>Climatic conditions</b>				
Storage (EN 60721-3-1)				1K3 (temperature: -30 °C ... +60 °C)
Operation (EN 60721-3-3)				3K3 (temperature: -30 °C ... +55 °C)
Transport (EN 60721-3-2)				2K3 (temperature: -30 °C ... +75 °C)
<b>Insulation voltage to reference earth/PE</b>				
EN 61800-5-1		U <sub>AC</sub>	[V]	50.0

4.2

### Connections

Mode	Features		Connections	Cable glands (possible connections)	Product key
Extended I/O	Controller enable Digital inputs Digital outputs Analog input Relay Safety function STO 24 V DC external	RFR TU DO AI NO STO 24 V	1 8 1 2 1 - -		E84DGFCXNNP

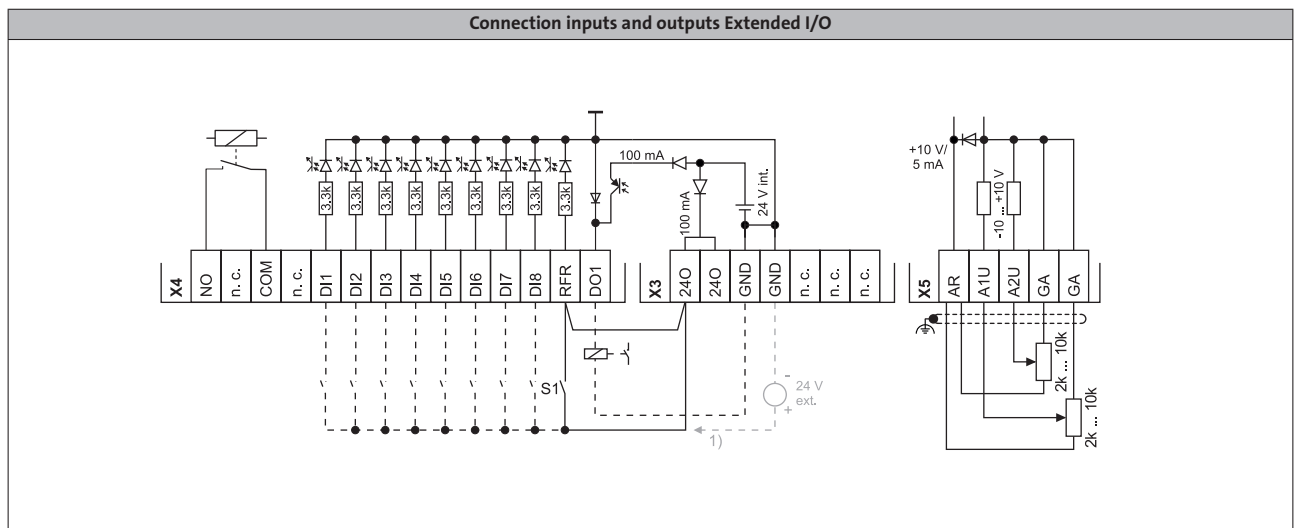

# Inverter Drives 8400 motec

## Module



### Communication module AS-Interface (AS-i)

The AS-Interface communication module enables you to control the 8400 motec using digital control signals. The AS-i bus system has become the established solution for transferring digital signals on the lowest field level. It is designed for applications that do not require the use of powerful fieldbus systems.

The advantages of this system are:

- Easy handling and commissioning
- Reduction in wiring complexity
- Easy integration into existing systems
- Cost reductions



AS-Interface communication module

### Standards and operating conditions

<b>Degree of protection</b>			
EN 60529			IP65
<b>Climatic conditions</b>			
Storage (EN 60721-3-1)			1K3 (temperature: -30 °C ... +60 °C)
Operation (EN 60721-3-3)			3K3 (temperature: -30 °C ... +55 °C)
Transport (EN 60721-3-2)			2K3 (temperature: -30 °C ... +75 °C)
<b>Insulation voltage to reference earth/PE</b>			
EN 61800-5-1	$U_{AC}$	[V]	50.0

### Technical data

<b>Standard</b>			
			EN 50295 / IEC 62026-2
<b>Communication</b>			
Communication profile			AS-Interface V3.0
Medium			2-wire cable for data and auxiliary power
<b>Network topology</b>			
			Free topology (line, ring, tree, star)
<b>Bus nodes</b>			
			Slave (single or dual) max. 31 standard slaves or safe slaves Max. 62 A/B slaves
<b>Number of bus nodes</b>			
			1 ... 31
<b>Max. cable length</b>			
per bus segment	$I_{max}$	[m]	100 without repeater / extender 300 with 2 repeaters / extenders 500 only for star-shaped mains including repeaters / extenders
<b>Baud rate</b>			
		[kbps]	167 (gross value) 53 (net with data transfer efficiency = 32%)
<b>Rated voltage</b>			
	$U_{N,DC}$	[V]	24.0

# Inverter Drives 8400 motec

Module



## AS-Interface communication module

### Connections

Mode	Features	Connections	Pin assignment	Pin arrangement	Product key
AS-Interface	Controller release (RFR)	1			E84DGFCFNP
	Digital inputs (DI)	5	DI1/2 to A4		
	Analogue inputs (AI)	-			
	Digital outputs (DO)	1			
	Relay (Rel)	-			
	LED network		LED to A1		
	Network	ASI+/ASI-	ASI+/ASI- to A2		

Mode	Features	Connections	Pin assignment	Pin arrangement	Product key
AS-Interface Enhanced	Controller release (RFR)	1			E84DGFCFNP
	Digital inputs (DI)	5	DI1/2 to A4 DI3 to B4		
	Analogue inputs (AI)	-			
	Digital outputs (DO)	1	D01 to B4		
	Relay (Rel)	-			
	LED network		LED to A1		
	Network	ASI+/ASI-	ASI+/ASI- to A2		

4.2

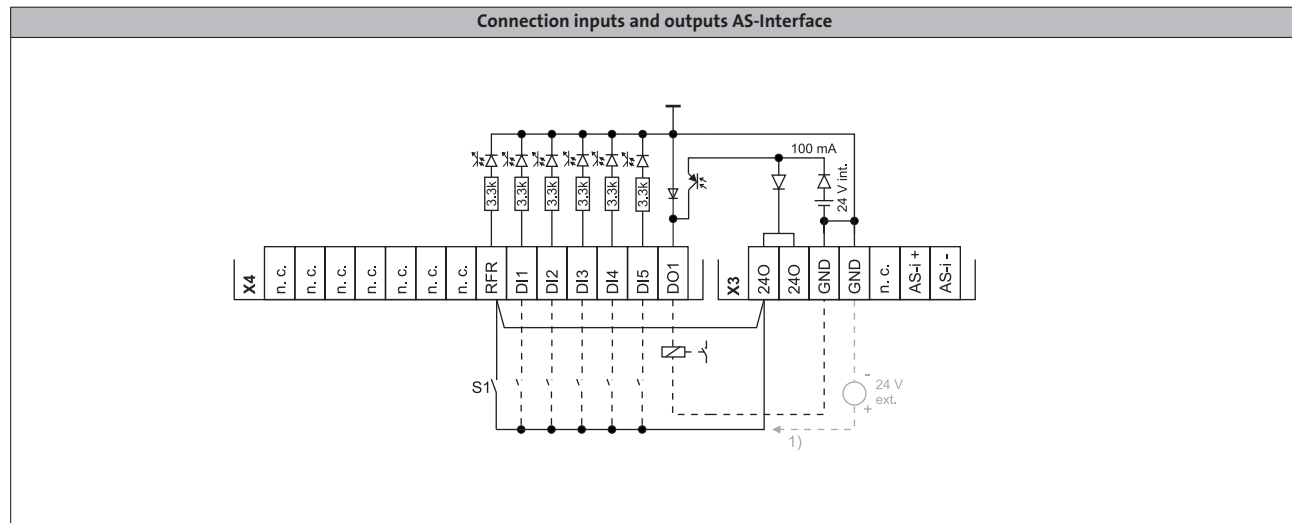

### M12 connector pin assignment

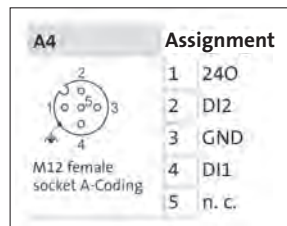
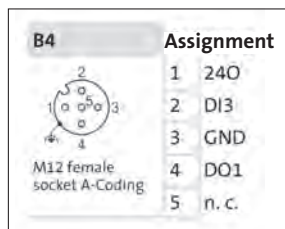
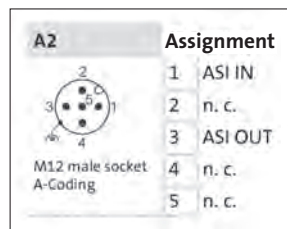



### AS-Interface communication module

#### Connections

Mode	Features	Connections	Pin assignment	Pin arrangement	Product key
AS-Interface STO	Controller release (RFR)	1			E84DGFCAFJP
	Digital inputs (DI)	5	DI1/2 to A4		
	Analogue inputs (AI)	1			
	Digital outputs (DO)	1			
	Relay (Rel)	1			
	LED network		LED to A1		
	Network	ASI+/ASI-	ASI+/ASI- to A2		
STO	SIA/SIB/GI/DO				

Mode	Features	Connections	Pin assignment	Pin arrangement	Product key
AS-Interface STO Enhanced	Controller release (RFR)	1			E84DGFCAEJP
	Digital inputs (DI)	5	DI1/2 to A4		
	Analogue inputs (AI)	1	A1 to B2		
	Digital outputs (DO)	1	D01 to B3		
	Relay (Rel)	1	Rel to B3		
	LED network		LED to A1		
	Network	ASI+/ASI-	ASI+/ASI- to A2		
STO	SIA/SIB/GI/DO	SIA/SIB/GI/DO to B4			

4.2

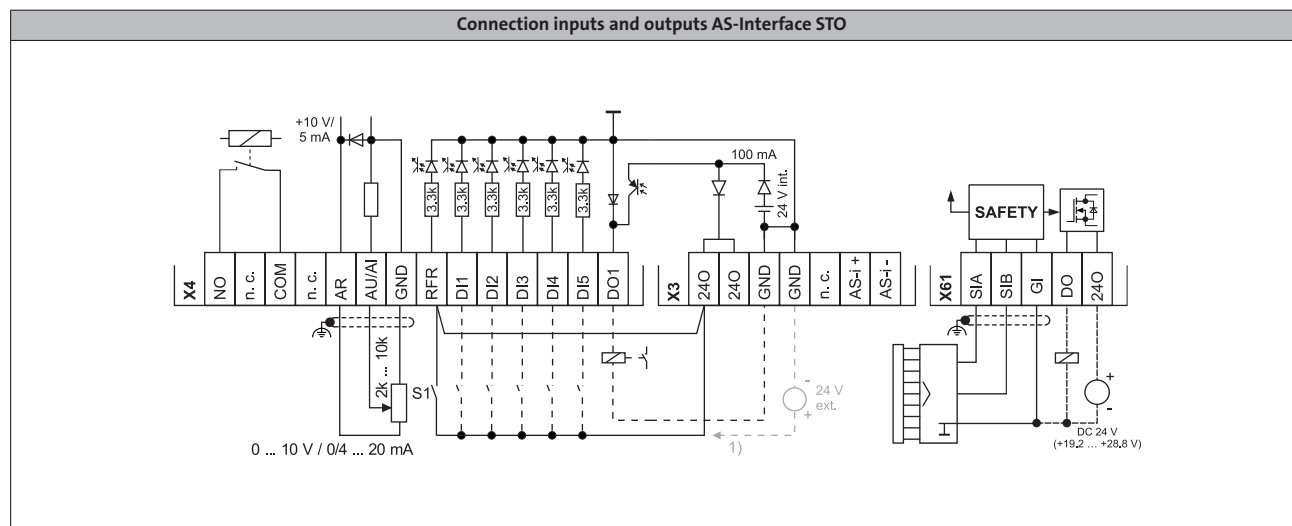

#### M12 connector pin assignment

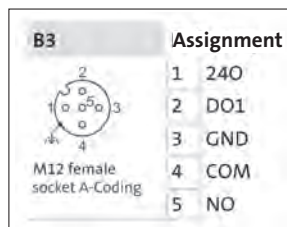
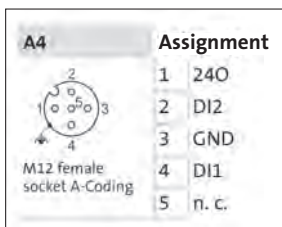
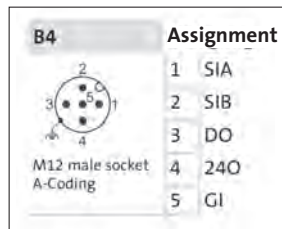
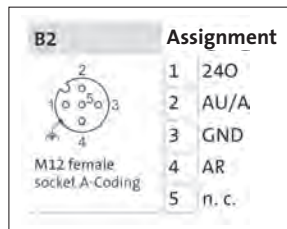
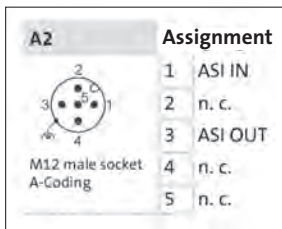

# Inverter Drives 8400 motec

## Module



### CANOpen communication module

The CANOpen communication module allows you to control the 8400 motec by sending digital control signals via the "CANopen" bus system.

The advantages of this system are:

- Straightforward, yet extremely powerful, bus system
- Cost-effective
- Easy system integration, as there is a wide range of sensors and actuators available on the market.



CANOpen communication module

### Standards and operating conditions

<b>Degree of protection</b>			
EN 60529			IP65
<b>Climatic conditions</b>			
Storage (EN 60721-3-1)			1K3 (temperature: -30 °C ... +60 °C)
Operation (EN 60721-3-3)			3K3 (temperature: -30 °C ... +55 °C)
Transport (EN 60721-3-2)			2K3 (temperature: -30 °C ... +75 °C)
<b>Insulation voltage to reference earth/PE</b>			
EN 61800-5-1	$U_{AC}$	[V]	50.0

4.2

### Technical data

<b>Communication</b>			
Medium			DIN ISO 11898
Communication profile			CANopen, DS301 V4.02 Lenze system bus
<b>Baud rate</b>	b	[kbps]	20 50 125 250 500 800 1000
<b>Bus nodes</b>			Slave Mini-master
<b>Network topology</b>			Line with terminating resistors (120 ohm) at both ends
<b>Number of logical process data channels</b>			2 Transmit PDOs and 2 Receive PDOs (each with 1 ... 8 bytes)
<b>Number of logical parameter data channels</b>			Max. 2 server SDO channels (with 1 - 8 bytes)
<b>Number of bus nodes</b>			63
<b>Max. cable length</b>	$l_{max}$	[m]	13 at 1000 kbps 38 at 800 kbps 113 at 500 kbps 275 at 250 kbps 600 at 125 kbps 1575 at 50 kbps 4013 at 20 kbps
<b>Rated voltage</b>	$U_{N,DC}$	[V]	24.0



### CANopen communication module

#### Connections

Mode	Features	Connections	Pin assignment	Pin arrangement	Product key
CAN	Controller release (RFR)	1			E84DGFCCFNP
	Digital inputs (DI)	5	DI1/2 to A4		
	Analogue inputs (AI)	-			
	Digital outputs (DO)	1			
	Relay (Rel)	-			
	Network	CAN input	CAN input to A2		
	Network	CAN output	CAN output to A3		

Mode	Features	Connections	Pin assignment	Pin arrangement	Product key
CAN Enhanced	Controller release (RFR)	1			E84DGFCCENP
	Digital inputs (DI)	5	DI1/2 to A4 DI13 to B4		
	Analogue inputs (AI)	-			
	Digital outputs (DO)	1	DO1 to B4		
	Relay (Rel)	-			
	Network	CAN input	CAN input to A2		
	Network	CAN output	CAN output to A3		

4.2

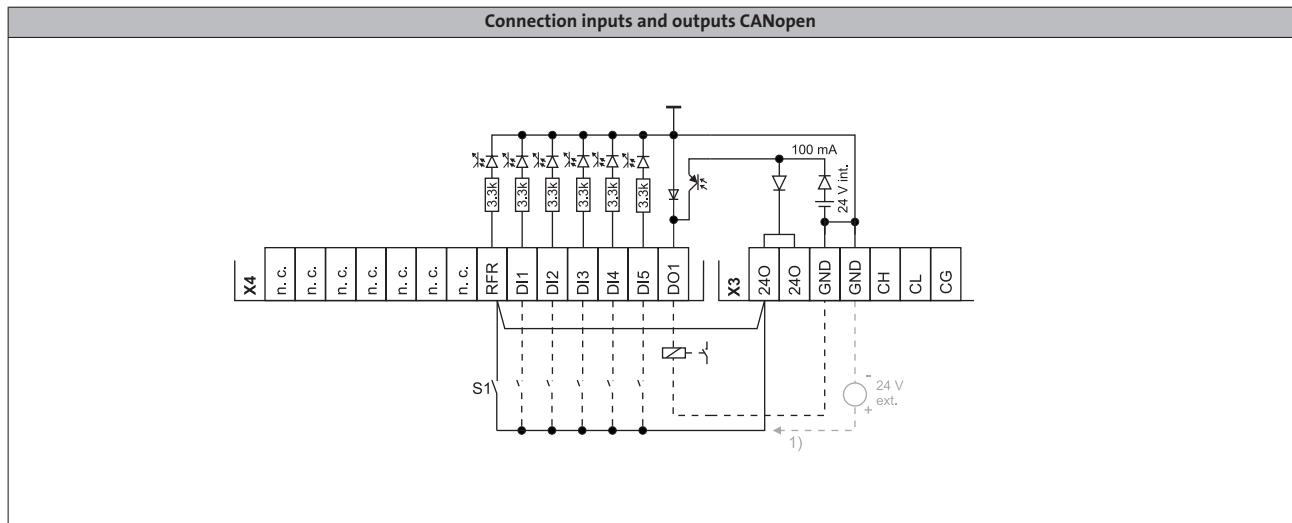

#### M12 connector pin assignment

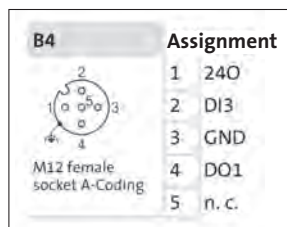
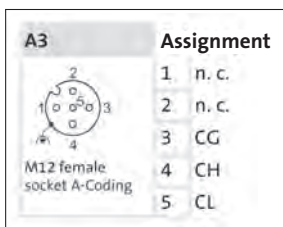
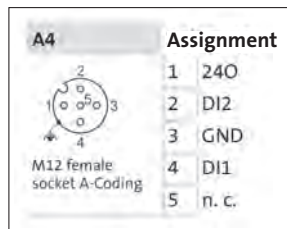
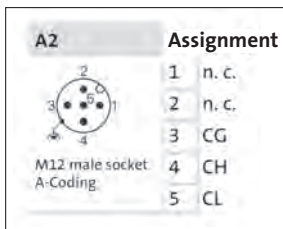

# Inverter Drives 8400 motec

## Module



### Connections

Mode	Features	Connections	Pin assignment	Pin arrangement	Product key
CAN STO	Controller release (RFR)	1			E84DGFCCFJP
	Digital inputs (DI)	5	DI1/2 to A4		
	Analogue inputs (AI)	1			
	Digital outputs (DO)	1			
	Relay (Rel)	1			
	Network	CAN input	CAN input to A2		
	Network	CAN output	CAN output to A3		
	STO	SIA/SIB/GI/DO			

Mode	Features	Connections	Pin assignment	Pin arrangement	Product key
CAN STO Enhanced	Controller release (RFR)	1			E84DGFCEJP
	Digital inputs (DI)	5	DI1/2 to A4		
	Analogue inputs (AI)	1	AI to B2		
	Digital outputs (DO)	1	DO1 to B3		
	Relay (Rel)	1	Rel to B3		
	Network	CAN input	CAN input to A2		
	Network	CAN output	CAN output to A3		
	STO	SIA/SIB/GI/DO	SIA/SIB/GI/DO to B4		

4.2

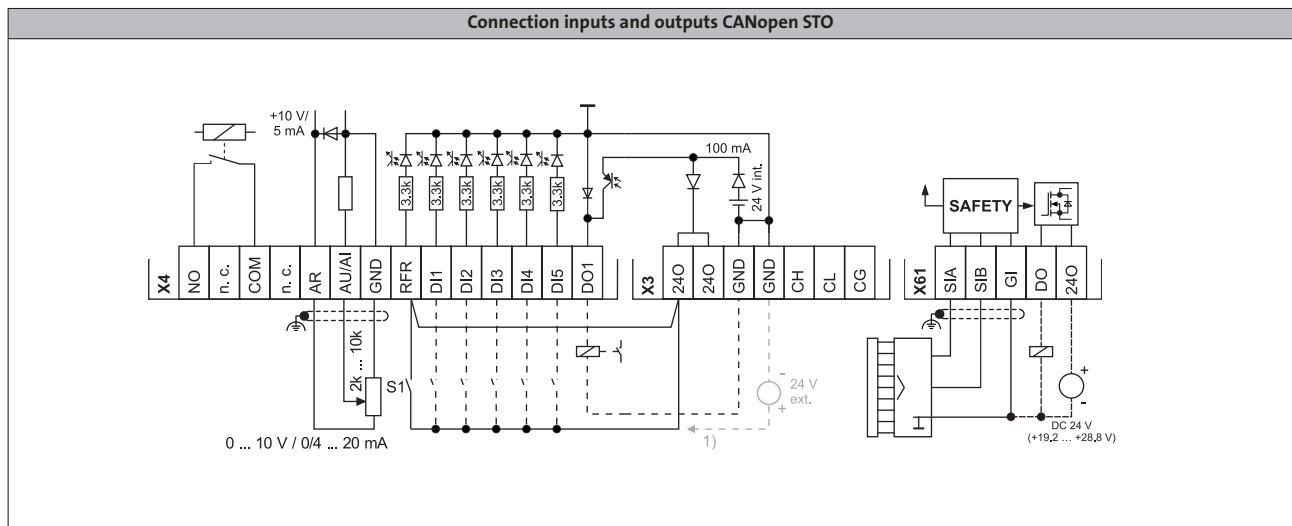

### M12 connector pin assignment

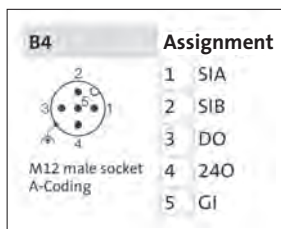
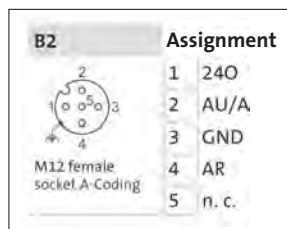
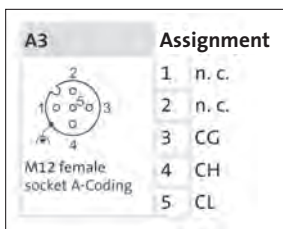
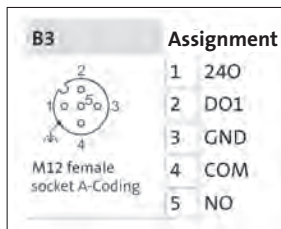
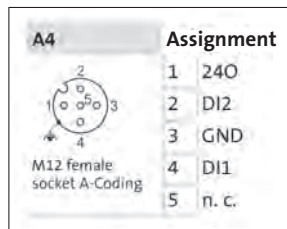
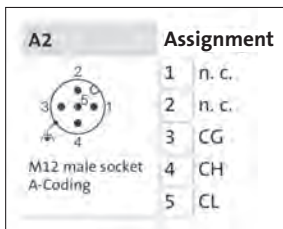

# Inverter Drives 8400 motec

## Module



### EtherCAT® communication module

With the communication module EtherCAT®, the Inverter Drives 8400 motec support continuous communication from the field level to the company management level.

The advantages of this system are:

- Use of IT standards
- Integrated switch allows direct looping of EtherCAT® via the inverters
- Integrated I/O node. Capable of communication and reading inputs even when the 400 V supply is switched off.
- Option for connecting a 24 V supply



EtherCAT® communication module

### Standards and operating conditions

<b>Degree of protection</b>			
EN 60529			IP65
<b>Climatic conditions</b>			
Storage (EN 60721-3-1)			1K3 (temperature: -30 °C ... +60 °C)
Operation (EN 60721-3-3)			3K3 (temperature: -30 °C ... +55 °C)
Transport (EN 60721-3-2)			2K3 (temperature: -30 °C ... +75 °C)
<b>Insulation voltage to reference earth/PE</b>			
EN 61800-5-1	$U_{AC}$	[V]	50.0

### Technical data

<b>Communication</b>			
Medium			CAT5e S/FTP in accordance with ISO/ICE11801 (2002)
Communication profile			CoE (CANopen over EtherCAT)
<b>Baud rate</b>			
	b	[kbps]	100
<b>Bus nodes</b>			
			Slave
<b>Network topology</b>			
			Line Switch
<b>Number of logical process data channels</b>			
			1
<b>Process data words (PCD)</b>			
to the master			1 ... 10 (max. 20 bytes, 16 bits/word)
from the master			1 ... 8 (max. 16 bytes, 16 bits/word)
<b>Parameter data</b>			
Max. mailbox size for CoE transfer		[Byte]	128
<b>Number of bus nodes</b>			
			Max. 65535
<b>Max. cable length</b>			
between two nodes	$l_{max}$	[m]	100 (typical)
<b>Rated voltage</b>			
	$U_{N,DC}$	[V]	24.0



# Inverter Drives 8400 motec

Module



## EtherCAT® communication module

### Connections

Mode	Features	Connections	Pin assignment	Pin arrangement	Product key
EtherCAT	Controller release (RFR)	1			E84DGFCTFNP
	Digital inputs (DI)	5	DI1/2 to A4		
	Analogue inputs (AI)	-			
	Digital outputs (DO)	1			
	Relay (Rel)	-			
	LED network		LED to A1		
	Network	EtherCAT In	EtherCAT In to A2		
Network	EtherCAT Out	EtherCAT Out to A3			

Mode	Features	Connections	Pin assignment	Pin arrangement	Product key
EtherCAT Enhanced	Controller release (RFR)	1			E84DGFCTENP
	Digital inputs (DI)	5	DI1/2 to A4 DI3 to B4		
	Analogue inputs (AI)	-			
	Digital outputs (DO)	1	DO1 to B4		
	Relay (Rel)	-			
	LED network		LED to A1		
	Network	EtherCAT In	EtherCAT In to A2		
Network	EtherCAT Out	EtherCAT Out to A3			

4.2

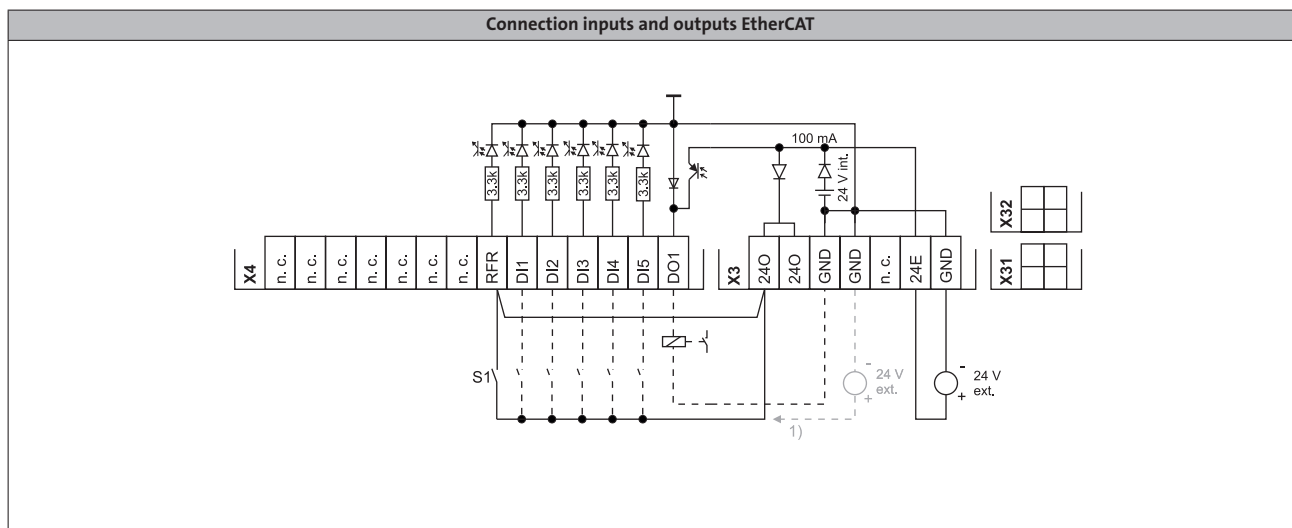

### M12 connector pin assignment

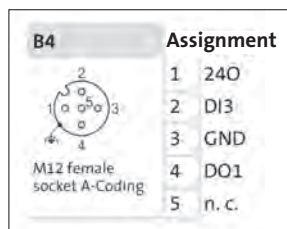
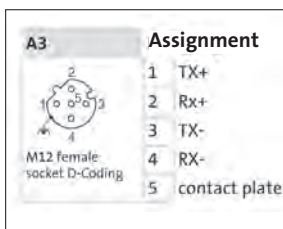
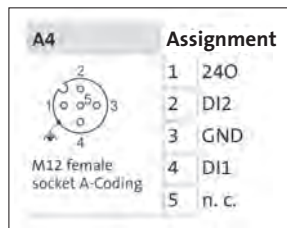
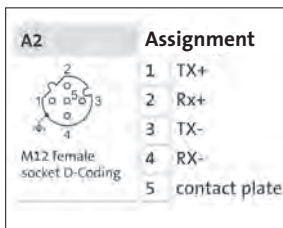

# Inverter Drives 8400 motec

## Module



### Connections

Mode	Features	Connections	Pin assignment	Pin arrangement	Product key
EtherCAT STO	Controller release (RFR)	1			E84DGFCTFJP
	Digital inputs (DI)	5	DI1/2 to A4		
	Analogue inputs (AI)	1			
	Digital outputs (DO)	1			
	Relay (Rel)	1			
	LED network		LED to A1		
	Network	EtherCAT In	EtherCAT In to A2		
	Network	EtherCAT Out	EtherCAT Out to A3		
STO	SIA/SIB/GI/DO	SIA/SIB/GI/DO to A4			

Mode	Features	Connections	Pin assignment	Pin arrangement	Product key
EtherCAT STO Enhanced	Controller release (RFR)	1			E84DGFCTEJP
	Digital inputs (DI)	5	DI1/2 to A4		
	Analogue inputs (AI)		AI to B2		
	Digital outputs (DO)	1	DO1 to B3		
	Relay (Rel)		Rel to B3		
	LED network		LED to A1		
	Network	EtherCAT In	EtherCAT In to A2		
	Network	EtherCAT Out	EtherCAT Out to A3		
STO	SIA/SIB/GI/DO	SIA/SIB/GI/DO to B4			

4.2

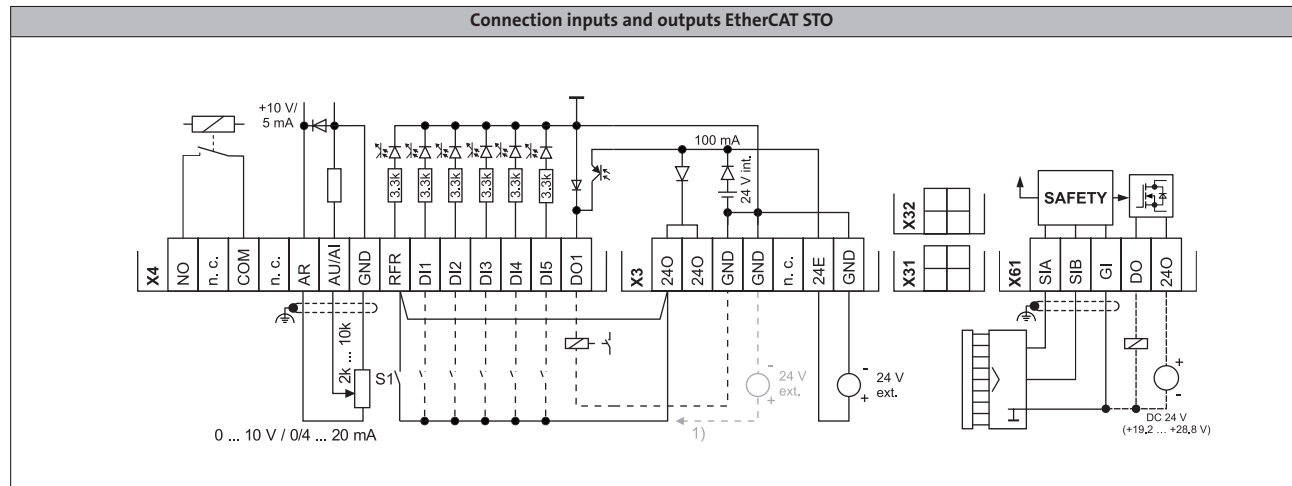

### M12 connector pin assignment

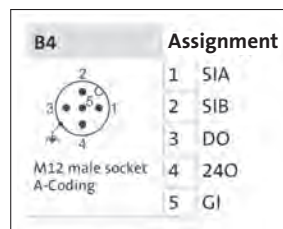
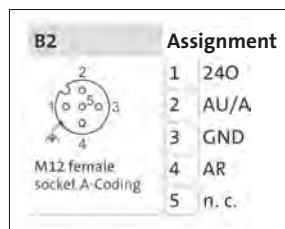
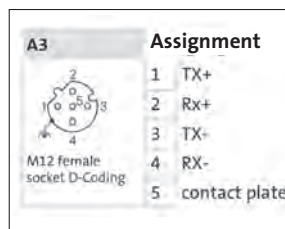
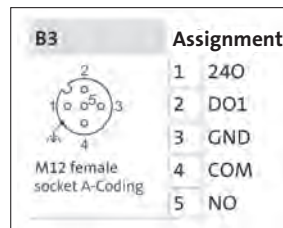
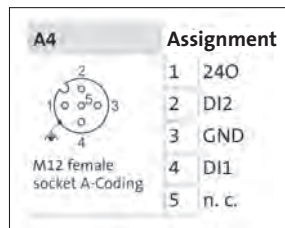
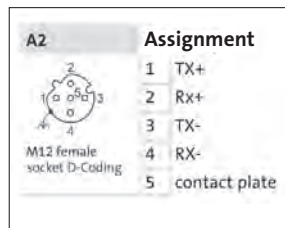

# Inverter Drives 8400 motec

Module



## EtherNet/IP communication module

The EtherNet/IP communication module based on standard TCP and UDP enables the Inverter Drives 8400 motec to support continuous communication from the field level right through to the controlling system.

The advantages of this system are:

- Currently widespread fieldbus based on real time Ethernet
- Supports DHCP and BootP in allocating the IP address
- Devices linked via EtherNet/IP can be implemented seamlessly and with minimum configuration effort via mapping into the I/O tree of the RSLogix programming tool.



EtherNet/IP communication module

## Standards and operating conditions

<b>Degree of protection</b>			
EN 60529			IP65
<b>Climatic conditions</b>			
Storage (EN 60721-3-1)			1K3 (temperature: -30 °C ... +60 °C)
Operation (EN 60721-3-3)			3K3 (temperature: -30 °C ... +55 °C)
Transport (EN 60721-3-2)			2K3 (temperature: -30 °C ... +75 °C)
<b>Insulation voltage to reference earth/PE</b>			
EN 61800-5-1	$U_{AC}$	[V]	50.0

4.2

## Technical data

<b>Communication</b>			
Medium			CAT5e S/FTP in accordance with ISO/ICE11801 / EN50173
Communication profile			EtherNET/IP, AC Drive
<b>Baud rate</b>			
		[Mbps]	10/100 (full duplex/half duplex)
<b>Bus nodes</b>			
			Slave (adapter)
<b>Network topology</b>			
			Tree, star, and line
<b>Number of logical process data channels</b>			
			1
<b>Process data words (PCD)</b>			
16 bits			1 ... 16
<b>Number of bus nodes</b>			
			Max. 254 in the subnetwork
<b>Max. cable length</b>			
between two nodes	$l_{max}$	[m]	100
<b>Rated voltage</b>			
	$U_{N,DC}$	[V]	24.0

# Inverter Drives 8400 motec

Module



## EtherNet/IP communication module

### Connections

Mode	Features	Connections	Pin assignment	Pin arrangement	Product key
EtherNet/IP	Controller release (RFR)	1			E84DGFCGFNP
	Digital inputs (DI)	5	DI1/2 to A4		
	Analogue inputs (AI)	-			
	Digital outputs (DO)	1			
	Relay (Rel)	-			
	LED network		LED to A1		
	Network	EtherNet/IP Port 1	EtherNet/IP Port 1 to A2		
Network	EtherNet/IP Port 2	EtherNet/IP Port 1 to A3			

Mode	Features	Connections	Pin assignment	Pin arrangement	Product key
EtherNet/IP Enhanced	Controller release (RFR)	1			E84DGFCGENP
	Digital inputs (DI)	5	DI1/2 to A4 DI3 to B4		
	Analogue inputs (AI)	-			
	Digital outputs (DO)	1	D01 to B4		
	Relay (Rel)	-			
	LED network		LED to A1		
	Network	EtherNet/IP Port 1	EtherNet/IP Port 1 to A2		
Network	EtherNet/IP Port 2	EtherNet/IP Port 1 to A3			

4.2

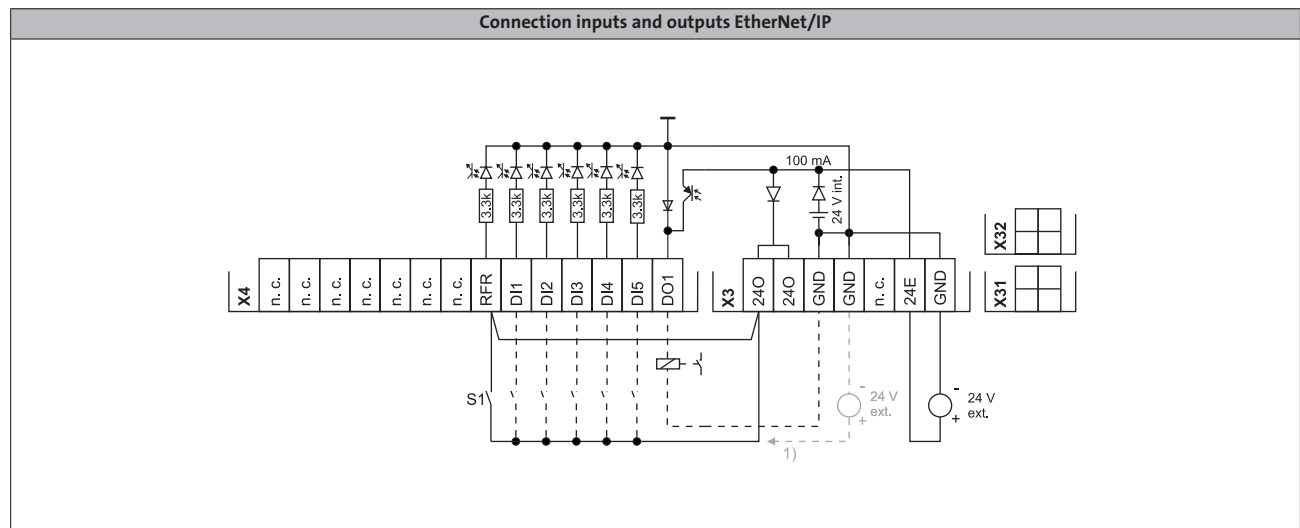

### M12 connector pin assignment

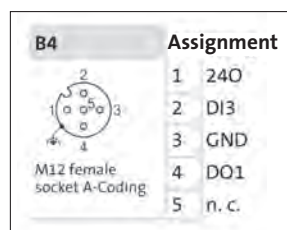
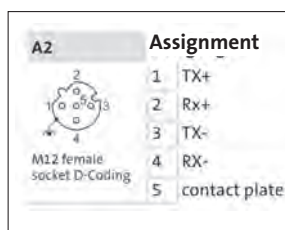
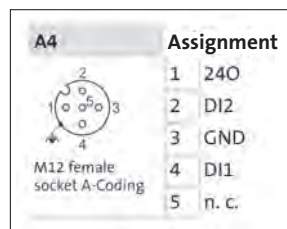
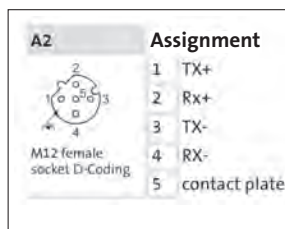

# Inverter Drives 8400 motec

## Module



### Connections

Mode	Features	Connections	Pin assignment	Pin arrangement	Product key
EtherNet/IP STO	Controller release (RFR)	1			E84DGFCGFJP
	Digital inputs (DI)	5	DI1/2 to A4		
	Analogue inputs (AI)	1			
	Digital outputs (DO)	1			
	Relay (Rel)	1			
	LED network		LED to A1		
	Network	EtherNet/IP Port 1	EtherNet/IP Port 1 to A2		
	Network	EtherNet/IP Port 2	EtherNet/IP Port 1 to A3		
STO	SIA/SIBGI/DO				

Mode	Features	Connections	Pin assignment	Pin arrangement	Product key
EtherNet/IP STO Enhanced	Controller release (RFR)	1			E84DGFCGEJP
	Digital inputs (DI)	5	DI1/2 to A4		
	Analogue inputs (AI)	1	AI to B2		
	Digital outputs (DO)	1	DO1 to B3		
	Relay (Rel)	1	Rel to B3		
	LED network		LED to A1		
	Network	EtherNet/IP Port 1	EtherNet/IP Port 1 to A2		
	Network	EtherNet/IP Port 2	EtherNet/IP Port 1 to A3		
	STO	SIA/SIBGI/DO	SIA/SIB/GI/DO to B4		

4.2

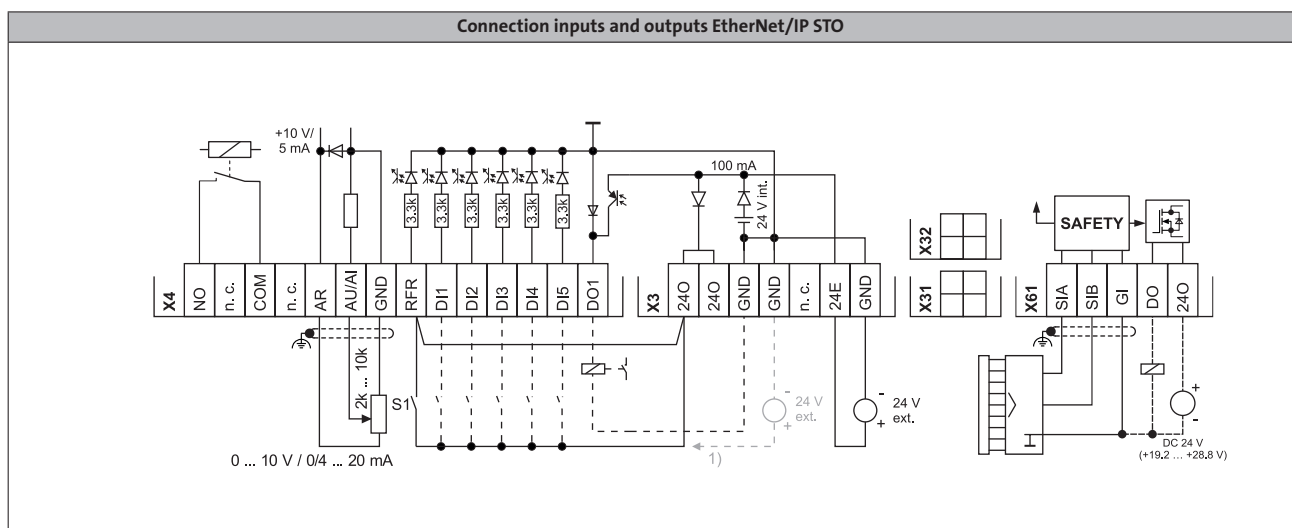

### M12 connector pin assignment

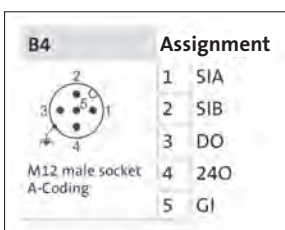
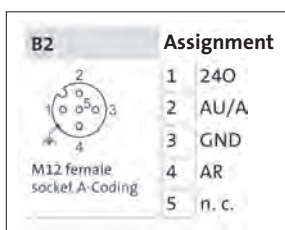
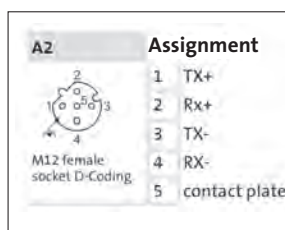
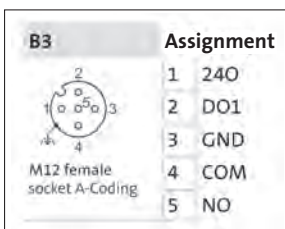
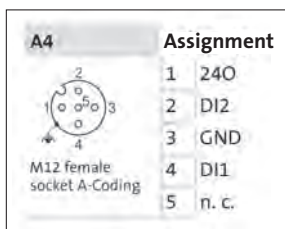
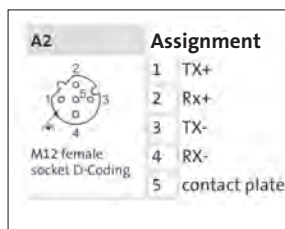

# Inverter Drives 8400 motec

## Module



### PROFIBUS communication module

When combined with the PROFIBUS communication module, the 8400 motec supports PROFIBUS, the most widely used fieldbus system today.

The advantages of this system are:

- Widely used and extremely powerful fieldbus system
- Integrated I/O node. Capable of communication and reading inputs even when the 400 V supply is switched off.
- Option for connecting a 24 V supply



PROFIBUS communication module

### Standards and operating conditions

<b>Degree of protection</b>			
EN 60529			IP65
<b>Climatic conditions</b>			
Storage (EN 60721-3-1)			1K3 (temperature: -30 °C ... +60 °C)
Operation (EN 60721-3-3)			3K3 (temperature: -30 °C ... +55 °C)
Transport (EN 60721-3-2)			2K3 (temperature: -30 °C ... +75 °C)
<b>Insulation voltage to reference earth/PE</b>			
EN 61800-5-1	$U_{AC}$	[V]	50.0

4.2

### Technical data

<b>Communication</b>			
Medium			RS 485
Communication profile			PROFIBUS-DP-V0 (DRIVECOM) PROFIBUS-DP-V1 (PROFIdrive)
<b>Baud rate</b>			
	b	[kbps]	9.6 ... 12 000 (automatic detection)
<b>Bus nodes</b>			
			Slave
<b>Network topology</b>			
			with repeater: line or tree without repeater: line
<b>Process data words (PCD)</b>			
16 bits			1 ... 8
<b>DP user data length</b>			
			Optional parameter channel (4 words) + process data words Acyclic parameter data channel (DP-V1): max. 240 bytes
<b>Number of bus nodes</b>			
			31 slaves + 1 master per bus segment With repeaters: 125
<b>Max. cable length</b>			
per bus segment	$l_{max}$	[m]	1200 (depending on the baud rate and the cable type used)
<b>Rated voltage</b>			
	$U_{N,DC}$	[V]	24.0

# Inverter Drives 8400 motec

Module



## PROFIBUS communication module

### Connections

Mode	Features	Connections	Pin assignment	Pin arrangement	Product key
PROFIBUS	Controller release (RFR)	1			E84DGFCPFNP
	Digital inputs (DI)	5	DI1/2 to A4		
	Analogue inputs (AI)	-			
	Digital outputs (DO)	1			
	Relay (Rel)	-			
	LED network		LED to A1		
	Network	PROFIBUS input	PROFIBUS input to A2		
	Network	PROFIBUS output	PROFIBUS output to A3		

Mode	Features	Connections	Pin assignment	Pin arrangement	Product key
PROFIBUS Enhanced	Controller release (RFR)	1			E84DGFCPENP
	Digital inputs (DI)	5	DI1/2 to A4 DI3 to B4		
	Analogue inputs (AI)	-			
	Digital outputs (DO)	1	D01 to B4		
	Relay (Rel)	-			
	LED network		LED to A1		
	Network	PROFIBUS input	PROFIBUS input to A2		
	Network	PROFIBUS output	PROFIBUS output to A3		

4.2

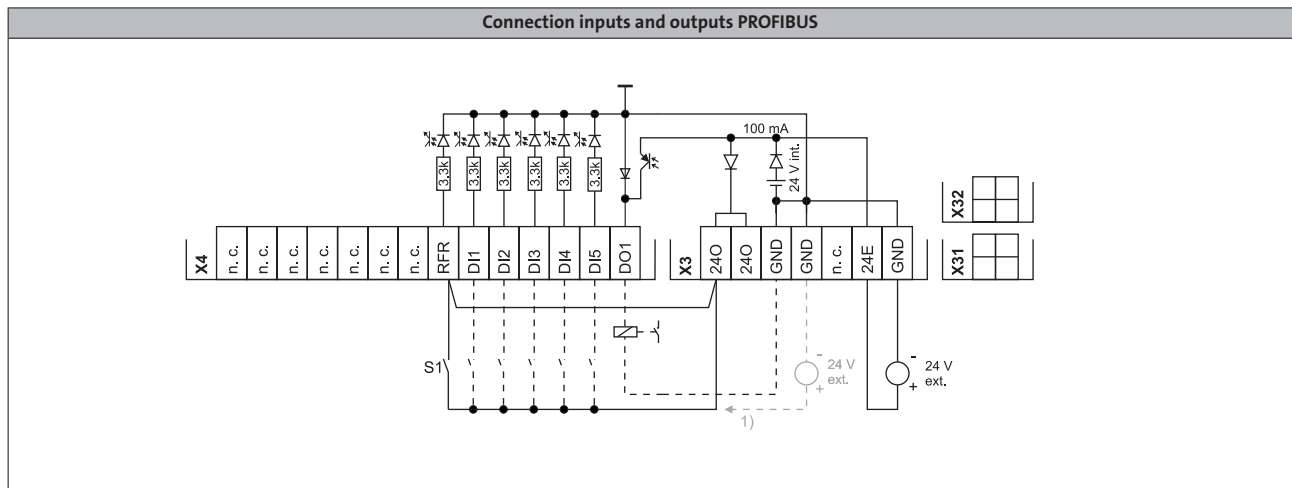

### M12 connector pin assignment

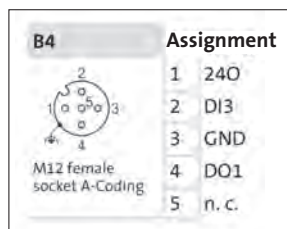
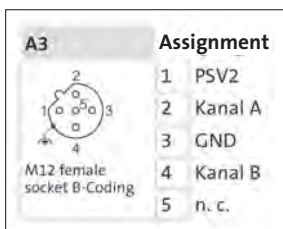
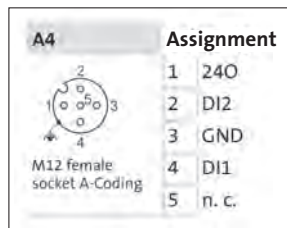
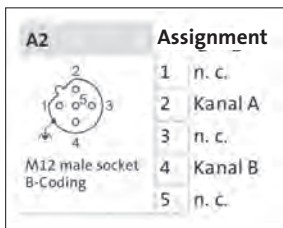

# Inverter Drives 8400 motec

Module



## Connections

Mode	Features	Connections	Pin assignment	Pin arrangement	Product key
PROFIBUS STO	Controller release (RFR)	1			E84DGFCPFJP
	Digital inputs (DI)	5	DI1/2 to A4		
	Analogue inputs (AI)	1			
	Digital outputs (DO)	1			
	Relay (Rel)	1			
	LED network		LED to A1		
	Network	PROFIBUS input	PROFIBUS input to A2		
	Network	PROFIBUS output	PROFIBUS output to A3		
STO	SIA/SIBGI/DO				

Mode	Features	Connections	Pin assignment	Pin arrangement	Product key
PROFIBUS STO Enhanced	Controller release (RFR)	1			E84DGFCPEJP
	Digital inputs (DI)	5	DI1/2 to A4		
	Analogue inputs (AI)	1	AI to B2		
	Digital outputs (DO)	1	D01 to B3		
	Relay (Rel)	1	Rel to B3		
	LED network		LED to A1		
	Network	PROFIBUS input	PROFIBUS input to A2		
	Network	PROFIBUS output	PROFIBUS output to A3		
STO	SIA/SIBGI/DO	SIA/SIB/GI/DO to B4			

4.2

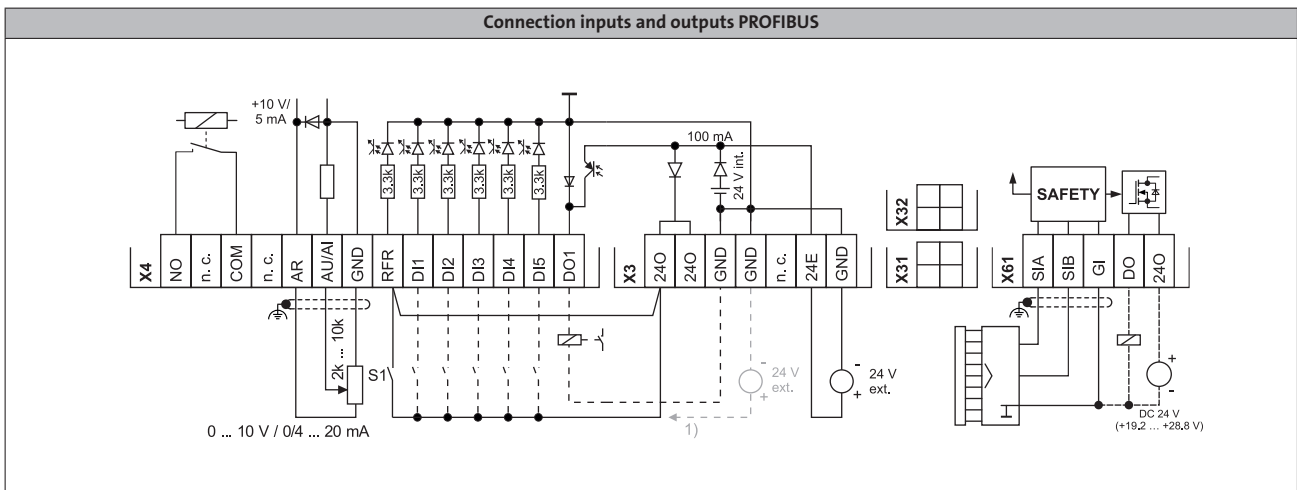

## M12 connector pin assignment

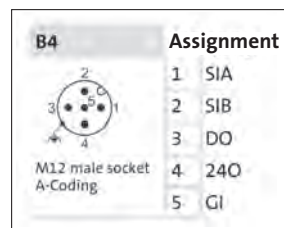
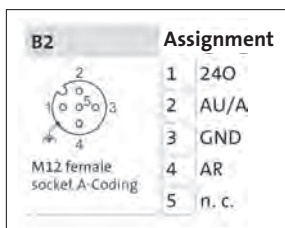
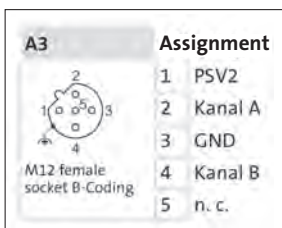
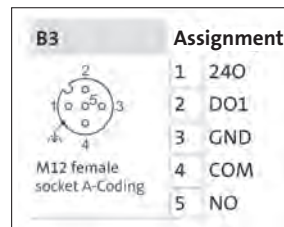
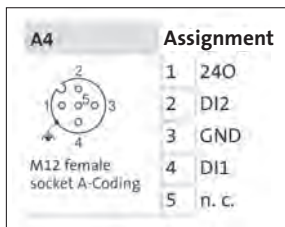
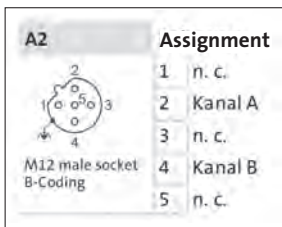



# Inverter Drives 8400 motec

Module



## PROFINET communication module

With the PROFINET communication module, the 8400 motec supports a fieldbus system for continuous communication from the field level right through to company management level. The advantages of this system are:

- Use of IT standards
- Integrated switch allows direct looping of PROFINET via the inverters
- Integrated I/O node. Capable of communication and reading inputs even when the 400 V supply is switched off.
- Option for connecting a 24 V supply



PROFINET communication module

## Standards and operating conditions

<b>Degree of protection</b>			
EN 60529			IP65
<b>Climatic conditions</b>			
Storage (EN 60721-3-1)			1K3 (temperature: -30 °C ... +60 °C)
Operation (EN 60721-3-3)			3K3 (temperature: -30 °C ... +55 °C)
Transport (EN 60721-3-2)			2K3 (temperature: -30 °C ... +75 °C)
<b>Insulation voltage to reference earth/PE</b>			
EN 61800-5-1	$U_{AC}$	[V]	50.0

4.2

## Technical data

<b>Communication</b>			
Medium			CAT5e S/FTP in accordance with ISO/ICE11801 (2002)
Communication profile			PROFINET RT Conf. Class B
<b>Baud rate</b>			
	b	[Mbps]	100
<b>Bus nodes</b>			
			Slave (device)
<b>Network topology</b>			
			Tree, star, and line
<b>Number of logical process data channels</b>			
			1
<b>Process data words (PCD)</b>			
			1 ... 10 data words to control system (16 bits/word, max. 20 bytes) 1 ... 8 data words from control system (16 bits/word, max. 16 bytes)
<b>Number of bus nodes</b>			
			31 slaves + 1 master per bus segment With repeaters: 125
<b>Max. cable length</b>			
between two nodes	$l_{max}$	[m]	100
<b>Rated voltage</b>			
	$U_{N,DC}$	[V]	24.0



### PROFINET communication module

#### Connections

Mode	Features	Connections	Pin assignment	Pin arrangement	Product key
PROFINET	Controller release (RFR)	1			E84DGFCRFNP
	Digital inputs (DI)	5	DI1/2 to A4		
	Analogue inputs (AI)	-			
	Digital outputs (DO)	1			
	Relay (Rel)	-			
	LED network		LED to A1		
	Network	PROFINET Port 1	PROFINET Port 1 to A2		
Network	PROFINET Port 2	PROFINET Port 2 to A3			

Mode	Features	Connections	Pin assignment	Pin arrangement	Product key
PROFINET Enhanced	Controller release (RFR)	1			E84DGFCRENPN
	Digital inputs (DI)	5	DI1/2 to A4 DI3 to B4		
	Analogue inputs (AI)	-			
	Digital outputs (DO)	1	D01 to B4		
	Relay (Rel)	-			
	LED network		LED to A1		
	Network	PROFINET Port 1	PROFINET Port 1 to A2		
Network	PROFINET Port 2	PROFINET Port 2 to A3			

4.2

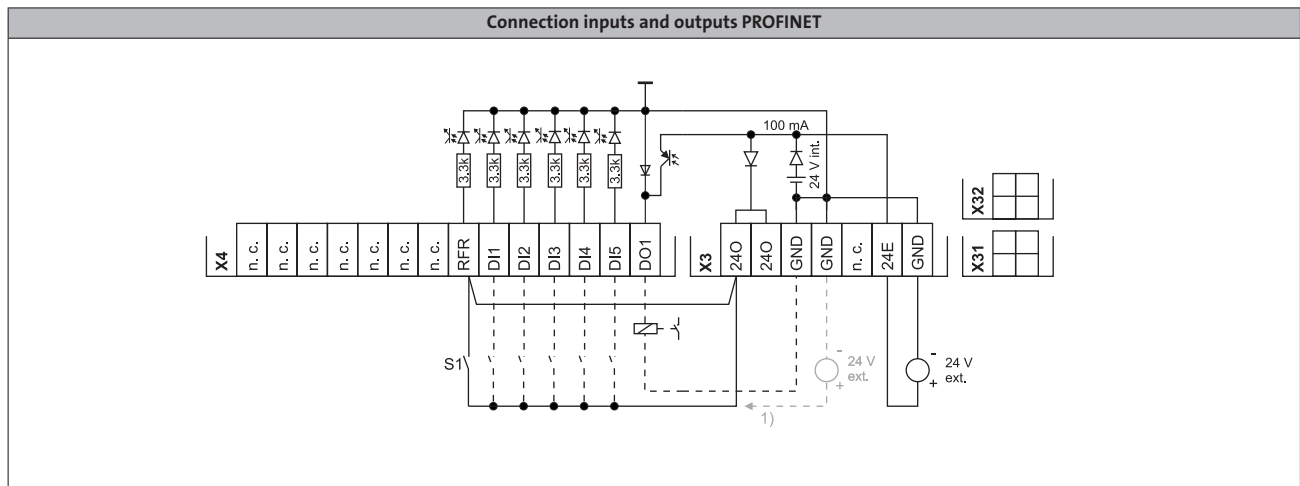

#### M12 connector pin assignment

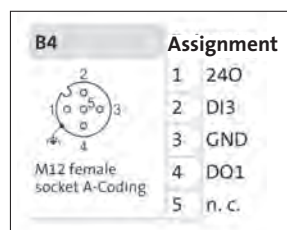
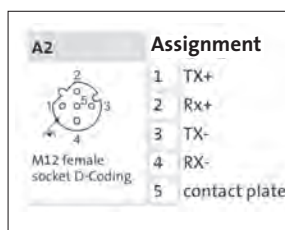
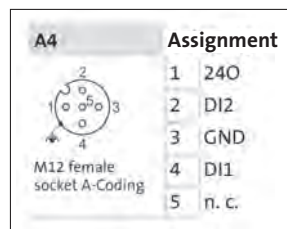
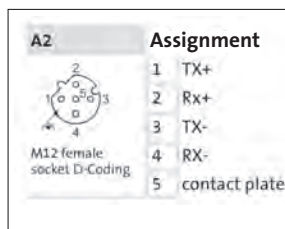

# Inverter Drives 8400 motec

Module



## Connections

Mode	Features	Connections	Pin assignment	Pin arrangement	Product key
PROFINET STO	Controller release (RFR)	1			E84DGFCRFJP
	Digital inputs (DI)	5	DI1/2 to A4		
	Analogue inputs (AI)	1			
	Digital outputs (DO)	1			
	Relay (Rel)	1			
	LED network		LED to A1		
	Network	PROFINET Port 1	PROFINET Port 1 to A2		
	Network	PROFINET Port 2	PROFINET Port 2 to A3		
STO	SIA/SIBGI/DO				

Mode	Features	Connections	Pin assignment	Pin arrangement	Product key
PROFINET STO Enhanced	Controller release (RFR)	1			E84DGFCREJP
	Digital inputs (DI)	5	DI1/2 to A4		
	Analogue inputs (AI)	1	AI to B2		
	Digital outputs (DO)	1	DO1 to B3		
	Relay (Rel)	1	Rel to B3		
	LED network		LED to A1		
	Network	PROFINET Port 1	PROFINET Port 1 to A2		
	Network	PROFINET Port 2	PROFINET Port 2 to A3		
STO	SIA/SIBGI/DO	SIA/SIB/GI/DO to B4			

4.2

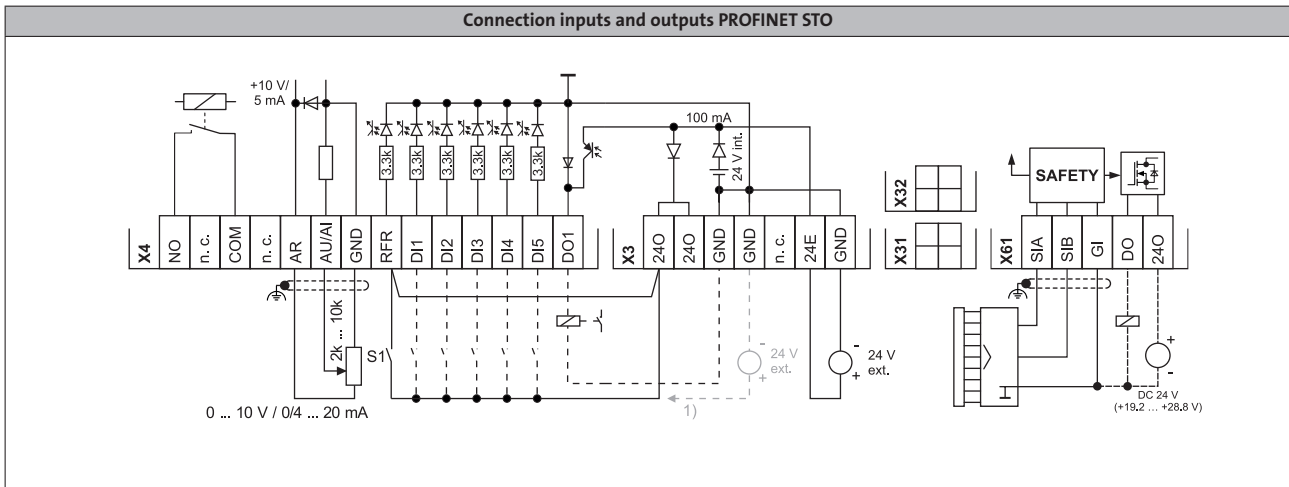

## M12 connector pin assignment

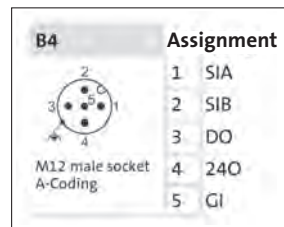
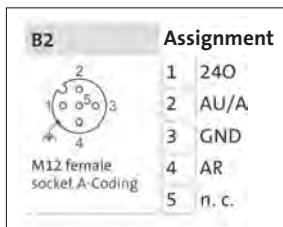
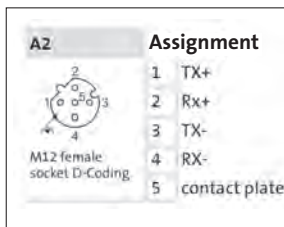
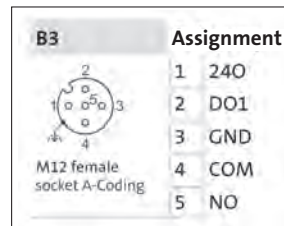
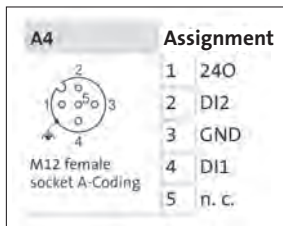
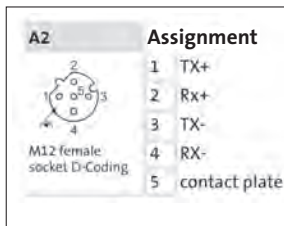

# Inverter Drives 8400 motec

## Module



### Wiring Unit for motor mounting

The Wiring Unit forms the interface between the various Lenze motors and inverters. In addition to this, it provides the flexibility in terms of connection options for mains connection, motor, brake and brake resistor.

The Wiring Unit also acts as a holder for various additional modules such as:

- Q5/0 plug-in module  
as Q5/0 plug connection or loop-through connection
- Q4/2 plug-in module  
as Q4/2 plug connection or loop-through connection
- Q8/0 Wiring Unit plug-in module  
as Q8/0 plug connection  
for the motor when wall mounted
- Quick-On connector for mains connection
- Attachable external brake resistor  
for braking operation via the integrated brake chopper



Wiring Unit



	E84DGVN1E	E84DGVN2E	E84DGVN3E	E84DGVN4E	E84DGVN5E
	Wiring Unit				
	<ul style="list-style-type: none"> <li>• For inverters E84DGDVB3714PS E84DGDVB5514PS E84DGDVB7514PS E84DGDVB1124PS</li> <li>• For motor frame sizes 063 and 071</li> </ul>	<ul style="list-style-type: none"> <li>• For inverters E84DGDVB5514PS E84DGDVB7514PS E84DGDVB1124PS E84DGDVB1524PS</li> <li>• For motor frame sizes 80, 090 and 100</li> </ul>	<ul style="list-style-type: none"> <li>• For inverters E84DGDVB2224PS E84DGDVB3024PS</li> <li>• For motor frame sizes 080, 090, 100 and 112</li> </ul>	<ul style="list-style-type: none"> <li>• For inverters E84DGDVB4024PS E84DGDVB5524PS E84DGDVB7524PS</li> <li>• For motor frame sizes 080, 090, 100 and 112</li> </ul>	<ul style="list-style-type: none"> <li>• For inverters E84DGDVB5524PS E84DGDVB7524PS</li> <li>• For motor frame size 132</li> </ul>

# Inverter Drives 8400 motec

Module



## Frame Unit without switch 0.37 to 3.0 kW (field package)

The Frame Unit without switch is a simple wiring and switch box for wall mounting and power class up to 3.0 kW. The Frame Unit without switch is available in 4 versions:

- In cable gland version
- In connector version, 1 x Quick-On for mains connection and 1 x HAN Q8 for motor connection
- With integrated brake resistor up to 30 watts with cable gland or connector



Frame Unit without switch

Product key	E84DGS2SCNNNP	E84DGS2SCNKNP	E84DGS2EENNNP	E84DGS2EENKNP
Mode	Pluggable		Cable gland	
Features	1x Quickon, 1x HAN Q8 • For E84DGDVB3714PS E84DGDVB5514PS E84DGDVB7514PS E84DGDVB1124PS E84DGDVB1154PS E84DGDVB2224PS E84DGDVB3024PS	1x Quickon, 1x HAN Q8, integrated brake resistor • For E84DGDVB3714PS E84DGDVB5514PS E84DGDVB7514PS E84DGDVB1124PS E84DGDVB1154PS E84DGDVB2224PS E84DGDVB3024PS	• For E84DGDVB3714PS E84DGDVB5514PS E84DGDVB7514PS E84DGDVB1124PS E84DGDVB1154PS E84DGDVB2224PS E84DGDVB3024PS	Integrated Brake resistor • For E84DGDVB3714PS E84DGDVB5514PS E84DGDVB7514PS E84DGDVB1124PS E84DGDVB1154PS E84DGDVB2224PS E84DGDVB3024PS

4.2

## Wall mounting 4.0 to 7.5 kW (field package without switch)

Wall mounting is used for the field package without switch, type 3, 4.0 to 7.5 kW. The wall mounting kit can either be purchased as a separate component or as part of a complete field package. The drive unit of the 8400 motec can be mounted directly on the wall mounting and meets degree of protection IP65.



Wall mounting

Product key			E84DZMAWE2
Mode			Wall mounting
Features			<ul style="list-style-type: none"> <li>• Degree of protection IP65</li> <li>• Easy installation</li> </ul> For <ul style="list-style-type: none"> <li>• E84DGDVB5524PS</li> <li>• E84DGDVB7524PS</li> </ul>

# Inverter Drives 8400 motec

## Module



### Frame Unit with switch for wall mounting

The Frame Unit with switch is a wiring and switch box for wall mounting and power class up to 3.0 kW. The Frame Unit with switch is available in the following combinations:

- In cable gland version
- In connector version, 2 x HAN Q4/2 for mains loops and 1 x HAN Q8 for motor connection
- With main switch
- With main switch and control elements
- With motor protection switch
- With integrated 15 watt brake resistor



Frame Unit with switch

Product key				
Service switch	E84DGS3KCBNND	E84DGS3KCBCND	E84DGS3LEBNND	E84DGS3LEBCND
Service switch with protective function	E84DGS3KCKNND	E84DGS3KCKCND	E84DGS3LEKNND	E84DGS3LEKCND
Service switch with control elements	E84DGS3KCENND	E84DGS3KCECND	E84DGS3LEENND	E84DGS3LEECND
<b>Mode</b>	Pluggable		Cable gland	
<b>Features</b>	2x HAN Q4/2, 1x HAN Q8 • For E84DGDVB3714PS E84DGDVB5514PS E84DGDVB7514PS E84DGDVB1124PS E84DGDVB1154PS E84DGDVB2224PS E84DGDVB3024PS	2x HAN Q4/2, 1x HAN Q8, integrated brake resistor • For E84DGDVB3714PS E84DGDVB5514PS E84DGDVB7514PS E84DGDVB1124PS E84DGDVB1154PS E84DGDVB2224PS E84DGDVB3024PS	• For E84DGDVB3714PS E84DGDVB5514PS E84DGDVB7514PS E84DGDVB1124PS E84DGDVB1154PS E84DGDVB2224PS E84DGDVB3024PS	integrated Brake resistor • For E84DGDVB3714PS E84DGDVB5514PS E84DGDVB7514PS E84DGDVB1124PS E84DGDVB1154PS E84DGDVB2224PS E84DGDVB3024PS

4.2

Switch functions			
Main switch	Mains supply on/off		
Motor protection switch	Mains supply on/off, 25A trip		
	Left position	Centre	Right position
Control element 1	Manual operation		Automatic
Control element 2	Motor counter-clockwise rotation		Motor clockwise rotation



Service switch



Service switch with protective function



Service switch with control elements

# Inverter Drives 8400 motec

Accessories



## Overview of possible components of the 8400 motec system

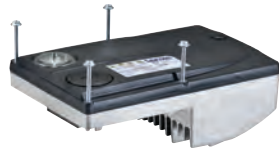

Drive Unit



USB diagnostic adapter - E94AZCUS



Diagnosis terminal - EZAEBK2003



Memory module - E84AYM205/M



Communication Unit



M-12 connector - EZA EVE013/M



Switch/potentiometer unit, connection via B-side - E82ZBU



Wiring Unit



External brake resistor

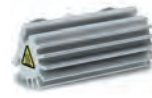

External brake resistor, can be mounted on the left or right of the wiring unit



Connector, can be mounted on left or right



Mounted on geared motor

4.2

# Inverter Drives 8400 motec

Accessories



## Memory module

All device settings for the 8400 are stored on a pluggable memory chip, the memory module. The memory module ensures that drives can be replaced quickly and without errors being made.



Mode	Features	Product key
Memory module	<ul style="list-style-type: none"> <li>• For 8400 BaseLine, 8400 motec</li> <li>• Packaging unit: 12 pcs.</li> </ul>	E84AYM20S/M

## M-12 connector

The M-12 plug-in connector can easily be added by breaking open the cutouts in the communication unit. The communication unit is wired by means of plug-in terminals. This means additional I/Os can also be plugged in.



Mode	Features	Product key
M-12 connector	<ul style="list-style-type: none"> <li>• A-coded, 5-pin, female</li> <li>• Packaging unit: 5 pcs.</li> </ul>	EZAEVE013/M

4.2

## Plug-in module

Screwed sockets for the mains connection are included on the Inverter Drives 8400 motec as standard. Alternatively, Q4, Q5 or Q8 plug-in modules can be used. Thanks to the universal connection options offered by the modules, a supply bus can be set up using plugs and couplings without the need for any external accessories.

Mounting of the plug-in module, right



Mounting of the plug-in module, left

## Plugs

Mode	Illustrations	Features	Product key
Plug-in module 1 x Q5/0 left		<ul style="list-style-type: none"> <li>• Applications with external mains distributor</li> <li>• 5 power contacts and PE: 16 A / 400 V</li> </ul>	E84DZEVBLANP
Plug-in module 1 x Q5/0 right			E84DZEVBRANP



# Inverter Drives 8400 motec

## Accessories



Mode	Illustrations	Features	Product key
Plug-in module 2 x Q5/0 left		<ul style="list-style-type: none"> <li>• Applications with mains loops</li> <li>• 5 power contacts and PE: 16 A / 400 V</li> </ul>	E84DZEVBALFP
Plug-in module 2 x Q5/0 right			E84DZEVBRAFP
Plug-in module 1 x Q4/2 left		<ul style="list-style-type: none"> <li>• Applications with external mains distributor</li> <li>• 4 power contacts and PE: 32 A / 400 V</li> <li>• 2 control contacts: 10 A / 24 V</li> </ul>	E84DZEVBALPNP
Plug-in module 1 x Q4/2 right			E84DZEVBRPNP
Plug-in module 2 x Q4/2 left		<ul style="list-style-type: none"> <li>• Applications with mains loops</li> <li>• 4 power contacts and PE: 32 A / 400 V</li> <li>• 2 control contacts: 10 A / 24 V</li> </ul>	E84DZEVBALPRP
Plug-in module 2 x Q4/2 right			E84DZEVBRPRP
Plug-in module 1 x Q8/0 left		<ul style="list-style-type: none"> <li>• Applications with 8400 motec in wall mounting</li> <li>• 8 power contacts and PE: 16 A / 400 V</li> <li>• Not suitable for rated power of 9.2 kW</li> </ul>	E84DZEVBLGNP
Plug-in module 1 x Q8/0 right			E84DZEVBRGNP
Plug-in module 1 x Q8/0 left 1 x Quickon		<ul style="list-style-type: none"> <li>• Applications with 8400 motec in wall mounting</li> <li>• Motor: 8 power contacts and PE: 16 A / 400 V</li> <li>• Mains: 3 power contacts and PE</li> <li>• Not suitable for rated power of 9.2 kW</li> </ul>	E84DZEVBLGNP
Quick-on connector		<ul style="list-style-type: none"> <li>• Applications with simple mains connection directly on the wiring unit</li> <li>• For all sizes, 20 A / 690 V (UL: 15 A / 690 V)</li> </ul>	EWS0092

# Inverter Drives 8400 motec

## Accessories



### Brake resistors

In order to decelerate higher moments of inertia or run in generator mode for longer periods of time, an external brake resistor is required. The resistor converts braking energy into heat. In addition to the optionally integrated 15/30 watt brake resistors in the field package, the following brake resistors are available.

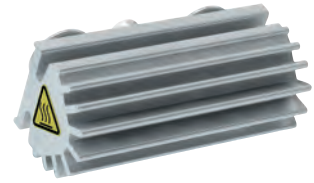

External brake resistor

### External brake resistor mounted on the wiring unit

An external brake resistor can be mounted on the side of the 8400 motec wiring unit or drive unit instead of the plug-in modules or cable gland.

Typical motor power	Mains voltage	Brake resistor	Rated resistor	Rated power	Thermal capacity
4-pole asynchronous motor					
P	$U_{AC}$		$R_N$	$P_N$	$C_{th}$
[kW]	[V]		[ $\Omega$ ]	[W]	[kW $s$ ]
0.37	3 AC 320 ... 528	E84DZEW220R0001	220.0	40.0	0.6
0.55					
0.75					
1.10		E84DZEW100R001	110.0		
1.50					
2.20		E84DZEW47R0001	47.0		
3.00					
4.00					
5.50					
7.50					

4.2

### External brake resistor

The brake resistors recommended in the table below have been dimensioned for approx. 1.5 times the regenerative power, with a cycle time of 15/135 s (brake/rest ratio). These brake resistors generally meet the usual requirements of standard applications.



Brake resistor

The brake resistors are fitted with a thermostat (potential-free normally-closed contact). The resistors meet IP65 (EN 60529) or type 4 (NEMA 250).

Typical motor power	Mains voltage	Brake resistor	Rated resistor	Rated power	Thermal capacity	Dimensions	Mass
4-pole asynchronous motor							
P	$U_{AC}$		$R_N$	$P_N$	$C_{th}$	h x w x d	m
[kW]	[V]		[ $\Omega$ ]	[W]	[kW $s$ ]	[mm]	[kg]
0.37	3 AC 320 ... 528	ERBS180R350W	180.0	350.0	53.0	382 x 124 x 122	2.0
0.55							
0.75							
1.10		ERBS100R625W	100.0	625.0	94.0	566 x 124 x 122	3.0
1.50							
2.20		ERBS047R400W ERBS047R800W	47.0	400.0	60.0	400 x 110 x 105	2.3
3.00							
4.00							
5.50							
7.50							

# Inverter Drives 8400 motec

## Accessories



### USB diagnostic adapter

The diagnosis terminal or a PC can be used to operate, parameterise and diagnose the Inverter Drives 8400 motec via the L-force diagnostic interface. A PC can be connected via the USB interface and the USB diagnostic adapter.

For connecting the USB diagnostic adapter to the L-force diagnostics interface (DIAG) on the inverter, three different cable lengths of 2.5 m, 5 m and 10 m are available separately. The 'EASY Starter' or 'Engineer' engineering tools can be used to operate, parameterise and diagnose the inverters. Both tools have simple intuitive interfaces. This enables e.g. quick and easy commissioning.

Instead of the USB diagnostic adapter, the PC system bus adapter can be used. This necessitates a CANopen interface on the inverter.

- The 'EASY Starter' or 'Engineer' engineering tools are used to operate, parameterise and diagnose the inverters.



USB diagnostic adapter  
incl. connecting cable to PC

4.2

Mode		Features	Product key
USB diagnostic adapter		<ul style="list-style-type: none"> <li>• Input side voltage supply via USB connection from PC</li> <li>• Output-side voltage supply via inverter's diagnostic interface</li> <li>• Diagnostic LEDs</li> <li>• Electrical isolation of PC and inverters</li> <li>• Supports hot plugging</li> </ul>	E94AZCUS

### Connecting cables for USB diagnostic adapter

Mode	Features	Product key
Connecting cable for USB diagnostic adapter	• Length: 2.5 m	EWL0070
	• Length: 5 m	EWL0071
	• Length: 10 m	EWL0072

# Inverter Drives 8400 motec

## Accessories



### Diagnosis terminal

The diagnosis terminal can be used as an alternative to a PC if you are looking for an easy way to operate the inverter, set parameters or carry out diagnostics locally. The structured menus and plain text display provide quick access to data. The diagnosis terminal can be plugged into the inverter's L-force diagnostic interface from the outside.



Diagnosis terminal

Mode	Features	Slot	Product key
Diagnosis terminal	<ul style="list-style-type: none"><li>• Diagnosis terminal in a robust housing</li><li>• Incl. 2.5 m cable</li><li>• Degree of protection IP20</li><li>• For 8400 motec and protec.</li></ul>	Diagnostic interface	EZAEBK2003

4.2

### Switch/potentiometer unit

The switch/potentiometer unit is fitted directly to the 8400 motec or in a different position within the system. An analogue setpoint can be specified with the switch/potentiometer unit and the control connections integrated in the inverter by using the integrated potentiometer; the rotary switch can, for example, be used to start/stop the drive or change the direction of rotation. The switch/potentiometer unit is supplied with a 2.5 m connection cable.



Switch/potentiometer unit

Mode	Product key
Switch/potentiometer unit (IP65)	E82ZBU

# Inverter Drives 8400 motec

Purchase order



## Motor mounting set

The components for motor mounting are supplied as a set.

A set comprises:

- Drive Unit
- Communication Unit
- Wiring Unit

Relevant accessories can be used to equip components to suit the application. They comprise:

- Connectors
- External brake resistors

The motor mounting units are customised by default for Lenze motor types 063 to 132, 0.37 to 7.5 kW.

The different units can be used in any desired combination within the power increments. This allows all connections to be implemented via cable glands and/or pluggable connectors. The seal to the terminal box supplied with the motor is used as the seal between the wiring unit and the motor.



8400 motec 0.37 ... 3.0 kW

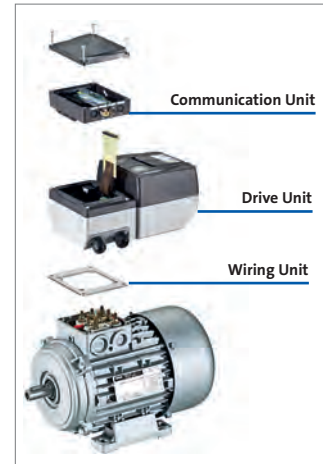

8400 motec 4.0 ... 7.5 kW

## Product key

Set motor mounted	E	8	4	D	V	B	M			4	S				2	P
Drive Unit, COM Unit and Wiring Unit as set																
<b>Output</b>																
0.37 kW							3	7	1							
0.55 kW							5	5	1							
0.75 kW							7	5	1							
1.10 kW							1	1	2							
1.50 kW							1	5	2							
2.20 kW							2	2	2							
3.00 kW							3	0	2							
4.00 kW							4	0	2							
5.50 kW							5	5	2							
7.50 kW							7	5	2							
<b>I/O module</b>																
Basic I/Os												N	N	N		
Standard I/O												S	N	N		
Extended I/O												X	N	N		
<b>Fieldbus</b>																
CAN												C	F	N		
CAN Enhanced												C	E	N		
CAN STO												C	F	J		
CAN STO Enhanced												C	E	J		
AS-Interface												A	F	N		
AS-Interface Enhanced												A	E	N		
AS-Interface STO												A	F	J		
AS-Interface STO Enhanced												A	E	J		
PROFIBUS												P	F	N		
PROFIBUS Enhanced												P	E	N		
PROFIBUS STO												P	F	J		
PROFIBUS STO Enhanced												P	E	J		
PROFINET												R	F	N		
PROFINET Enhanced												R	E	N		
PROFINET STO												R	F	J		
PROFINET STO Enhanced												R	E	J		
EtherCAT												T	F	N		
EtherCAT Enhanced												T	E	N		
EtherCAT STO												T	F	J		
CAN STO Enhanced												T	E	J		
EtherNet IP												G	F	N		
EtherNet Enhanced												G	E	N		
EtherNet STO												G	F	J		
EtherNet STO Enhanced												G	E	J		
<b>Motor frame size</b>																
(063/071) for 0.37 ...1.1 kW																1
(080/090/100) for 0.55 ...1.5 kW																2
(080/090/100/112) for 2.2 ... 3.0 kW																3
(080/090/100/112) for 4.0 ... 7.5 kW																4
(132) for 5.5 ... 7.5 kW																5

# Inverter Drives 8400 motec

Purchase order



## Accessories

0.37 ... 3.0 kW

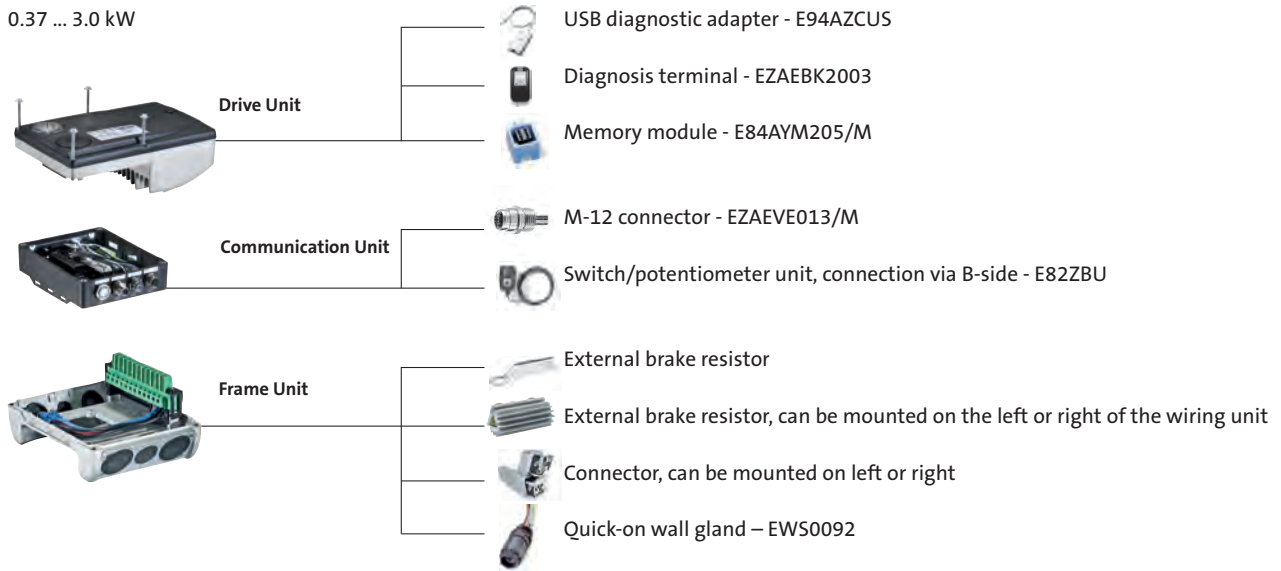

4.2

4.0 ... 7.5 kW

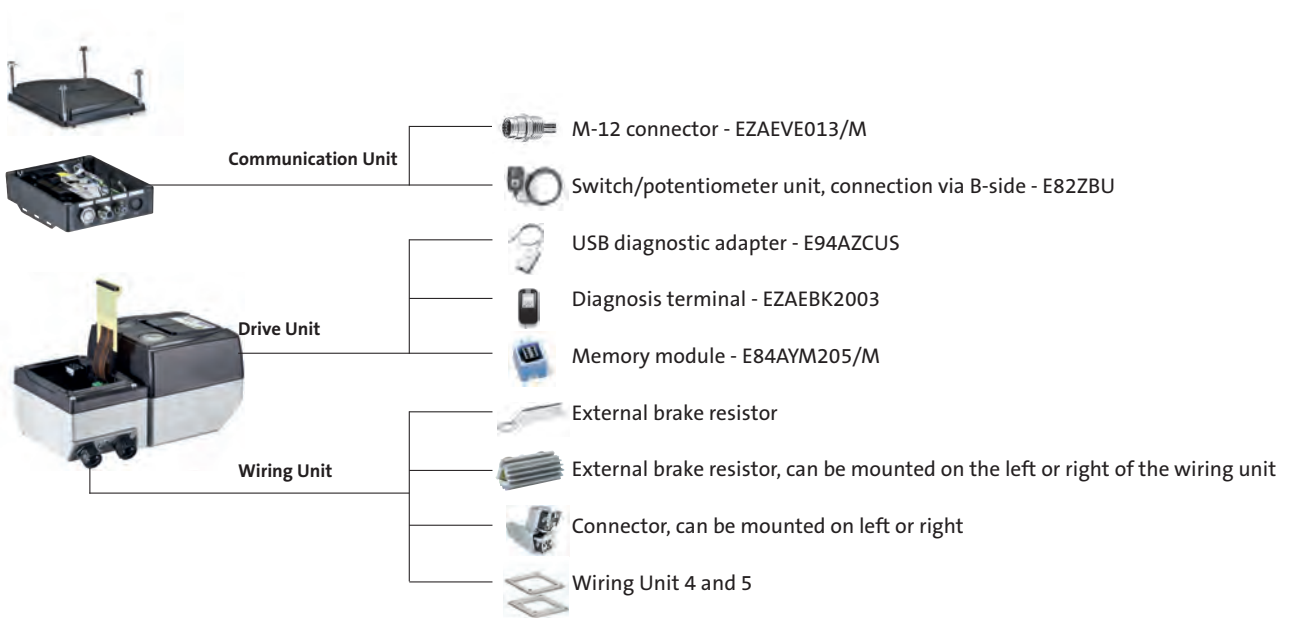

# Inverter Drives 8400 motec

Purchase order



## Field package without switch

In the cable gland version, the components for wall mounting from 0.37 to 3.0 kW are supplied as a set.

One set consists of individually packed boxes:

- Drive Unit
- Communication Unit
- Frame Unit without switch

In the cable gland version, the components for wall mounting from 4.0 to 7.5 kW are supplied as a set.

One set consists of individually packed boxes:

- Drive Unit
- Communication Unit
- Wall mount

The 0.37 to 7.5 kW type with plug-in connector is supplied in one completely mounted unit as a drive packet. The field package (0.37 to 3.0 kW) can be ordered with an internal brake resistor with 90 ohms, 30 W, 0.3 kW.



0.37 to 3.0 kW



4.0 to 7.5 kW

## Product key

Field package 2	Z	2	5		0										F	0	0
Mains connection 1 x Quick-On, motor connection 1 x Q8, supplied as one unit					C	0											S
Mains connection, motor connection, cable connection, supplied as set					A	0											K
<b>Brake resistor</b>																	
No						0											
Integrated 30 watt (90 ohms) <sup>1)</sup>						B											
Mounted on drive unit, 40 watt (47 ohms), available for 4.0 to 7.5 kW.						C											
<b>I/O module</b>																	
Basic I/Os							0	A	0	A							
Standard I/O							0	B	0	A							
Extended I/O							0	D	0	A							
<b>Fieldbus</b>																	
CAN							C	C	0	E							
CAN Enhanced							C	C	0	J							
CAN STO							C	B	A	E							
CAN STO Enhanced							C	B	A	F							
AS-Interface							A	C	0	C							
AS-Interface Enhanced							A	C	0	I							
AS-Interface STO							A	B	A	C							
AS-Interface STO Enhanced							A	B	A	D							
PROFIBUS							P	C	0	G							
PROFIBUS Enhanced							P	C	0	K							
PROFIBUS STO							P	B	A	G							
PROFIBUS STO Enhanced							P	B	A	H							
PROFINET							R	C	0	G							
PROFINET Enhanced							R	C	0	K							
PROFINET STO							R	B	A	G							
PROFINET STO Enhanced							R	B	A	H							
EtherCAT							T	C	0	G							
EtherCAT Enhanced							T	C	0	K							
EtherCAT STO							T	B	A	G							
CAN STO Enhanced							T	B	A	H							
EtherNet IP							G	C	0	G							
EtherNet IP Enhanced							G	C	0	K							
EtherNet IP STO							G	B	A	G							
EtherNet IP STO Enhanced							G	B	A	H							
<b>Output</b>																	
0.37 kW											1	3	7				
0.55 kW											1	5	5				
0.75 kW											1	7	5				
1.10 kW											2	1	1				
1.50 kW											2	1	5				
2.20 kW											2	2	2				
3.00 kW											2	3	0				
4.00 kW											2	4	0				
5.50 kW											2	5	5				
7.50 kW											2	7	5				

<sup>1)</sup> Option up to 3.0 kW

# Inverter Drives 8400 motec

Purchase order



## Accessories

### 0.37 to 3.0 kW

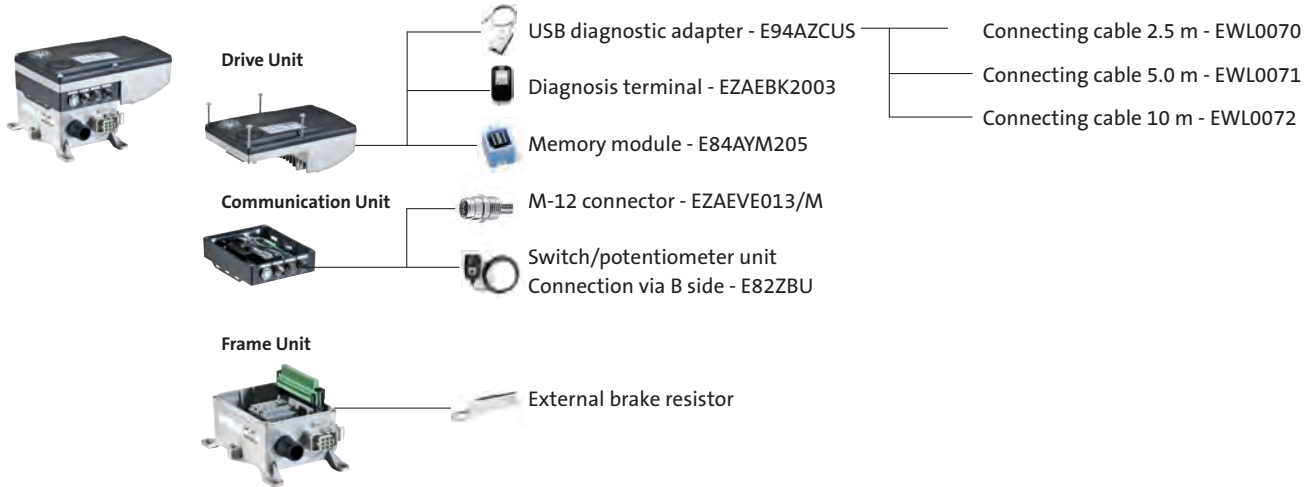

4.2

### 4.0 to 7.5 kW

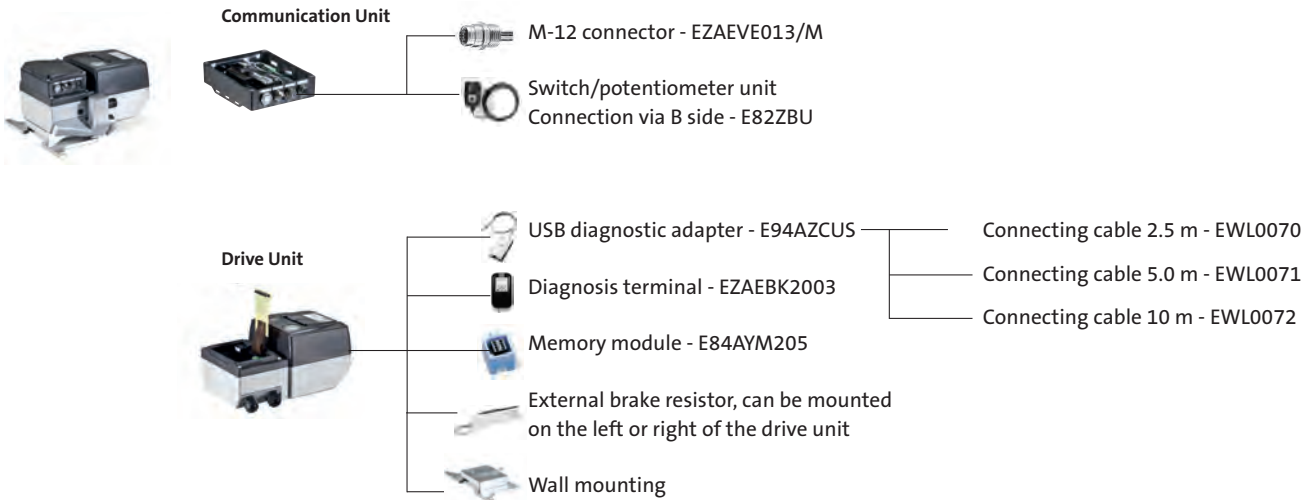



# Inverter Drives 8400 motec

Purchase order



## Field package with switch

In the cable gland version, the components for wall mounting from 0.37 to 3.0 kW are supplied as a set. A set comprises:

- Drive Unit
- Communication Unit
- Frame Unit with switch

The 0.37 to 3.0 kW type with plug-in connector is supplied in one completely mounted unit as a drive packet.

When assembling the connector version 2 x HAN Q4/2 can be added to enable direct loop-through of mains supply.



0.37 to 3.0 kW

## Product key

Mains connection 2 x Q4/2, motor connection 1 x Q8 Supplied as 1 unit	B	B																					S
Mains connection, motor connection cable gland Supplied as set	A	0																					K
maintenance switch only			A																				
with protective function			B																				
and control elements			C																				
No			0																				
Integrated 15 watt (220 ohms)			A																				
Basic I/Os				0	A	0	A																
Standard I/O				0	B	0	A																
Extended I/O				0	D	0	A																
CAN				C	C	0	E																
CAN Enhanced				C	C	0	J																
CAN STO				C	B	A	E																
CAN STO Enhanced				C	B	A	F																
AS-Interface				A	C	0	C																
AS-Interface Enhanced				A	C	0	I																
AS-Interface STO				A	B	A	C																
AS-Interface STO Enhanced				A	B	A	D																
PROFIBUS				P	C	0	G																
PROFIBUS Enhanced				P	C	0	K																
PROFIBUS STO				P	B	A	G																
PROFIBUS STO Enhanced				P	B	A	H																
PROFINET				R	C	0	G																
PROFINET Enhanced				R	C	0	K																
PROFINET STO				R	B	A	G																
PROFINET STO Enhanced				R	B	A	H																
EtherCAT				T	C	0	G																
EtherCAT Enhanced				T	C	0	K																
EtherCAT STO				T	B	A	G																
CAN STO Enhanced				T	B	A	H																
EtherNet IP				G	C	0	G																
EtherNet IP Enhanced				G	C	0	K																
EtherNet IP STO				G	B	A	G																
EtherNet IP STO Enhanced				G	B	A	H																
0.37 kW											1	3	7										
0.55 kW											1	5	5										
0.75 kW											1	7	5										
1.10 kW											2	1	1										
1.50 kW											2	1	5										
2.20 kW											2	2	2										
3.00 kW											2	3	0										

4.2

# Inverter Drives 8400 motec

Purchase order



---

## Accessories

0.37 to 3.0 kW



Drive Unit



Frame Unit



USB diagnostic adapter - E94AZCUS



Diagnosis terminal - EZAEBK2003



Memory module - E84AYM205



M-12 connector - EZA EVE013/M



Switch/potentiometer unit

Connection via B side - E82ZBU

Connecting cable 2.5 m - EWL0070

Connecting cable 5.0 m - EWL0071

Connecting cable 10 m - EWL0072



